

Digital Video Camera Recorder ^{Mini DV} Digital Video Cassette

Operating Instructions

Before operating the unit, please read this manual thoroughly, and retain it for future reference.

Owner's Record

The model and serial numbers are located on the bottom. Record the serial number in the space provided below. Refer to these numbers whenever you call upon your Sony dealer regarding this product.

Model No. **DCR-TRV** _____ Model No. **AC-** _____

Serial No. _____ Serial No. _____

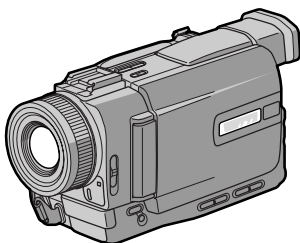

DCR-TRV20

Digital Handycam



DCR-TRV6/TRV11/TRV20

Welcome!

Congratulations on your purchase of this Sony Digital Handycam camcorder. With your Digital Handycam, you can capture life's precious moments with superior picture and sound quality. Your Digital Handycam is loaded with advanced features, but at the same time it is very easy to use. You will soon be producing home video that you can enjoy for years to come.

WARNING

To prevent fire or shock hazard, do not expose the unit to rain or moisture.

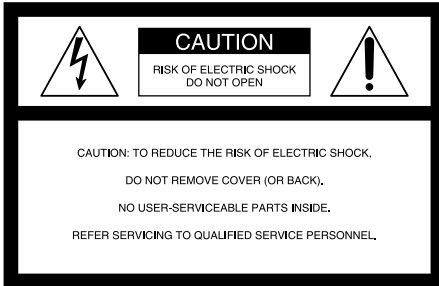

This symbol is intended to alert the user to the presence of uninsulated "dangerous voltage" within the product's enclosure that may be of sufficient magnitude to constitute a risk of electric shock to persons.



This symbol is intended to alert the user to the presence of important operating and maintenance (servicing) instructions in the literature accompanying the appliance.

Never expose the battery pack to temperatures above 140°F (60°C) such as in a car parked in the sun or under direct sunlight.

For customers in the U.S.A. and CANADA

DISPOSAL OF LITHIUM ION BATTERY. LITHIUM ION BATTERY. DISPOSE OF PROPERLY.

You can return your unwanted lithium ion batteries to your nearest Sony Service Center or Factory Service Center.

Note: In some areas the disposal of lithium ion batteries in household or business trash may be prohibited.

For the Sony Service Center nearest you call 1-800-222-SONY (United States only).
For the Sony Factory Service Center nearest you call 416-499-SONY (Canada only).

Caution: Do not handle damaged or leaking lithium ion battery.

For the Customers in the U.S.A.

If you have any questions about this product, you may call :
Sony Customer Information Center 1-800-222-SONY (7669) or
write to : Sony Customer Information Center 1 Sony Drive, Mail Drop #T1-11, Park Ridge, NJ, 07656.

Declaration of Conformity

Trade Name: SONY
Model No.: DCR-TRV6,
DCR-TRV11
Responsible Party: Sony Electronics Inc.
Address: 1 Sony Drive, Park
Ridge, NJ, 07656 USA
Telephone No.: 201-930-6972

This device complies with Part 15 of the FCC Rules. Operation is subject to the following two conditions.: (1) This device may not cause harmful interference, and (2) this device must accept any interference received, including interference that may cause undesired operation.

Declaration of Conformity

Trade Name: SONY
Model No.: DCR-TRV20
Responsible Party: Sony Electronics Inc.
Address: 1 Sony Drive, Park
Ridge, NJ, 07656 USA
Telephone No.: 201-930-6972

This device complies with Part 15 of the FCC Rules. Operation is subject to the following two conditions.: (1) This device may not cause harmful interference, and (2) this device must accept any interference received, including interference that may cause undesired operation.

"Memory Stick"

This device complies with Part 15 of the FCC Rules. Operation is subject to the following two conditions: (1) This device may not cause harmful interference, and (2) this device must accept any interference received, including interference that may cause undesired operation.

CAUTION

You are cautioned that any changes or modifications not expressly approved in this manual could void your authority to operate this equipment.

Note:

This equipment has been tested and found to comply with the limits for a Class B digital device, pursuant to Part 15 of the FCC Rules. These limits are designed to provide reasonable protection against harmful interference in a residential installation. This equipment generates, uses, and can radiate radio frequency energy and, if not installed and used in accordance with the instructions, may cause harmful interference to radio communications. However, there is no guarantee that interference will not occur in a particular installation. If this equipment does cause harmful interference to radio or television reception, which can be determined by turning the equipment off and on, the user is encouraged to try to correct the interference by one or more of the following measures:

- Reorient or relocate the receiving antenna.
- Increase the separation between the equipment and receiver.
- Connect the equipment into an outlet on a circuit different from that to which the receiver is connected.
- Consult the dealer or an experienced radio/TV technician for help.

For customers in CANADA**CAUTION**

TO PREVENT ELECTRIC SHOCK, MATCH WIDE BLADE OF PLUG TO WIDE SLOT, FULLY INSERT.

This Class B digital apparatus complies with Canadian ICES-003.

Table of contents

Checking supplied accessories	5
Quick Start Guide	6

Getting started

Using this manual	8
Step 1 Preparing the power supply	10
Installing the battery pack	10
Charging the battery pack	11
Connecting to a wall outlet	14
Step 2 Inserting a cassette	15

Recording – Basics

Recording a picture	16
Shooting backlit subjects (BACK LIGHT)	21
Shooting in the dark (NightShot/Super NightShot) ...	22
Self-timer recording	23
Checking the recording – END SEARCH/EDITSEARCH/Rec	
Review	24

Playback – Basics

Playing back a tape	25
Viewing the recording on TV	28

Advanced Recording Operations

Recording a still image on a tape	
– Tape Photo recording	30
Adjusting the white balance manually ...	33
Using the wide mode	34
Using the fader function	35
Using special effects – Picture effect ...	37
Using special effects – Digital effect ...	38
Using the PROGRAM AE function	41
Adjusting the exposure manually	43
Focusing manually	44

Advanced Playback Operations

Playing back a tape with picture effects ...	45
Playing back a tape with digital effects ...	46
Enlarging images recorded on tapes	
– PB ZOOM	47
Quickly locating a scene using the zero set memory function	48
Searching the boundaries of recorded tape by title – Title search	49
Searching a recording by date	
– Date search	50
Searching for a photo – Photo search/Photo scan	52

Editing

Dubbing a tape	54
Dubbing only desired scenes	
– Digital program editing	56

Using with analog video unit and PC	
– Signal convert function	66
Recording video or TV programs	67
Inserting a scene from a VCR	
– Insert editing	71
Audio dubbing	73
Superimposing a title	77
Making your own titles	81
Labeling a cassette	83

Customizing Your Camcorder

Changing the menu settings	85
Resetting the date and time	92

“Memory Stick” Operations

(DCR-TRV11/TRV20 only)	
Using a “Memory Stick”	
– introduction	93
Recording still images on “Memory Stick”s	
– Memory photo recording	100
Superimposing a still picture in a “Memory Stick” on a moving picture – MEMORY MIX	105
Recording an image from a mini DV tape as a still image	108
Copying still images from a mini DV tape – Photo save	111
Viewing a still picture – Memory photo playback	113
Copying the image recorded on “Memory Stick”s to mini DV tapes	116
Enlarging still images recorded on “Memory Stick”s	
– Memory PB ZOOM	118
Playing back images in a continuous loop	
– SLIDE SHOW	119
Preventing accidental erasure	
– Image protection	120
Deleting images	121
Writing a print mark – PRINT MARK ...	123

Additional Information

Usable cassettes	124
About i.LINK	126
Troubleshooting	128
Self-diagnosis display	134
Warning indicators and messages ...	135
Using your camcorder abroad	137
Maintenance information and precautions	138
Specifications	142

Quick Reference

Identifying the parts and controls	144
Quick Function Guide	151
Index	Back cover

Checking supplied accessories

Make sure that the following accessories are supplied with your camcorder.

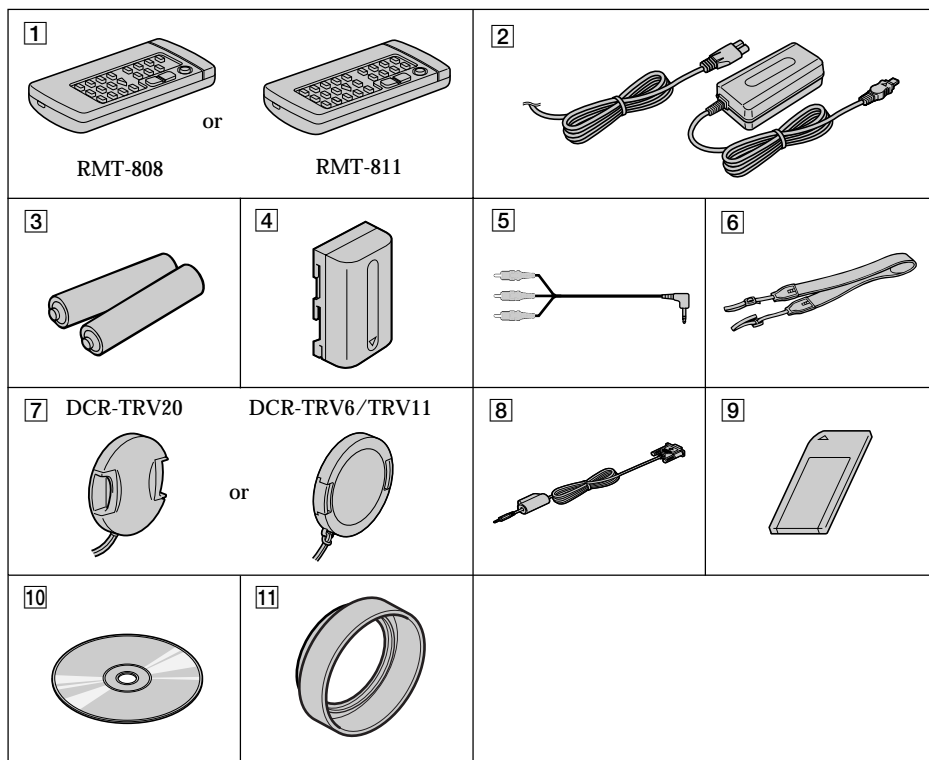

- 1 Wireless Remote Commander (1)
(p. 149)
RMT-808: DCR-TRV6
RMT-811: DCR-TRV11/TRV20
- 2 AC-L10A/L10B/L10C AC power adaptor
(1), Power cord (1) (p. 11)
- 3 Size AA (R6) battery for Remote
Commander (2) (p. 149)
- 4 NP-FM50 battery pack (1) (p. 10, 11)
- 5 A/V connecting cable (1) (p. 28, 54)
- 6 Shoulder strap (1) (p. 144)

- 7 Lens cap (1) (p. 16)
- 8 PC serial cable (1) (p. 115)
DCR-TRV11/TRV20 only
- 9 "Memory Stick" (1) (p. 93)
DCR-TRV11/TRV20 only
- 10 Application software: PictureGear
4.1Lite (CD ROM) (1) (p. 115)
DCR-TRV11/TRV20 only
- 11 Lens hood (1) (p. 19)
DCR-TRV20 only

Quick Start Guide



This chapter introduces you to the basic features of your camcorder. See the page in parentheses “()” for more information.

1 Connecting the power cord (p. 14)

Use the battery pack when using your camcorder outdoors (p. 10).

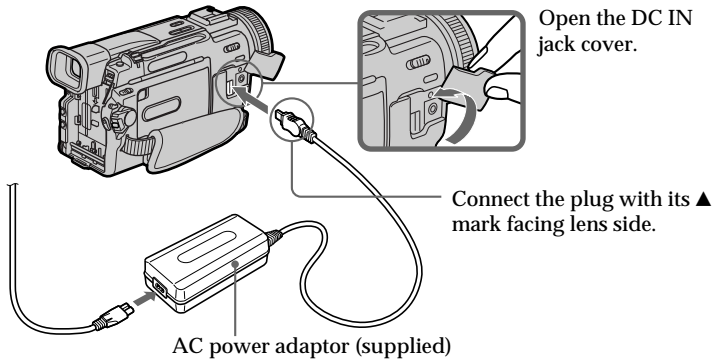

2 Inserting a cassette (p. 15)

- 1 Slide OPEN/EJECT in the direction of the arrow and open the lid.

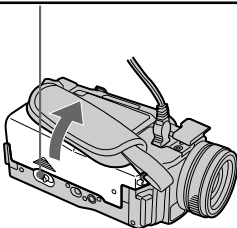

- 2 Push the middle portion of the back of the cassette to insert.
- 3 Close the cassette compartment by pressing the **PUSH** mark on the cassette compartment.

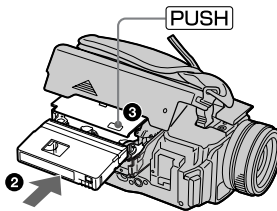

- 4 After the cassette compartment going down completely, close the lid until it clicks.

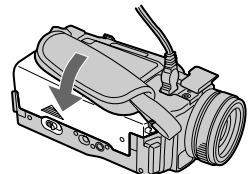

3 Recording a picture (p. 16)

1 Remove the lens cap.

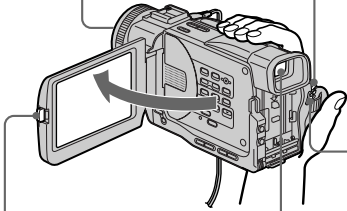

2 Set the POWER switch to CAMERA while pressing the small green button.

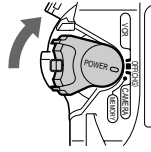

4 Press START/STOP. Your camcorder starts recording. To stop recording, press START/STOP again.



3 To open the LCD panel, press OPEN. The picture appears on the LCD screen.

Viewfinder
When the LCD panel is closed, use the viewfinder placing your eye against its eyecup.

4 Monitoring the playback picture on the LCD screen (p. 25)

1 Set the POWER switch to VCR while pressing the small green button.

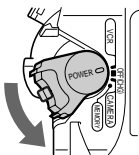

2 Press ◀ to rewind the tape.



3 Press ▶ to start playback.

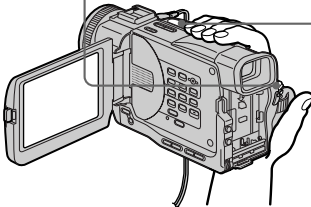

NOTE

Do not pick up your camcorder by holding the viewfinder or the LCD panel.

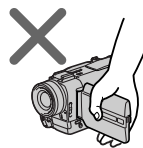
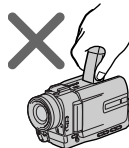

Using this manual

The instructions in this manual are for the three models listed in the table below. Before you start reading this manual and operating your camcorder, check the model number by looking at the bottom of your camcorder. The DCR-TRV20 is the model used for illustration purposes. Otherwise, the model name is indicated in the illustrations. Any differences in operation are clearly indicated in the text, for example, “DCR-TRV20 only”.

As you read through this manual, buttons and settings on your camcorder are shown in capital letters.

e.g. Set the POWER switch to CAMERA.

When you carry out an operation, you can hear a beep sound to indicate that the operation is being carried out.

Types of differences

DCR-	TRV6	TRV11	TRV20
MEMORY mark* (on the POWER switch)	—	●	●

- Provided
- Not provided

* The model with MEMORY marked on the POWER switch is provided with memory functions. See page 93 for details.

Note on Cassette Memory

Your camcorder is based on the DV format. You can only use mini DV cassettes with your camcorder. We recommend that you use a tape with cassette memory **CM**.

The functions which require different operations depending on whether the tape has the cassette memory or not are:

- End search (p. 24, 27)
- Searching a recording by date – date search (p. 50)
- Photo search (p. 52).

The functions you can operate only with the cassette memory are:

- Searching the boundaries of recorded tape by title – title search (p. 49)
- Superimposing a title (p. 77)
- Making your own titles (p. 81)
- Labeling a cassette (p. 83).

For details, see page 124.



You see this mark in the introduction of the features that are operated only with cassette memory.

Tapes with cassette memory are marked by **CM** (Cassette Memory).

Using this manual

Note on TV color systems

TV color systems differ from country to country. To view your recordings on a TV, you need an NTSC system-based TV.

Copyright precautions

Television programs, films, video tapes, and other materials may be copyrighted. Unauthorized recording of such materials may be contrary to the provision of the copyright laws.

Precautions on camcorder care

- The LCD screen and the viewfinder are manufactured using high-precision technology. However, there may be some tiny black points and/or bright points (red, blue, green, or white) that constantly appear on the LCD screen and in the viewfinder. These points occur normally in the manufacturing process and do not affect the recorded picture in any way. Effective ratio of pixels and/or screen are 99.99% or more.
- Do not let your camcorder get wet. Keep your camcorder away from rain and sea water. Letting your camcorder get wet may cause your camcorder to malfunction. Sometimes this malfunction cannot be repaired [a].
- Never leave your camcorder exposed to temperatures above 140°F (60°C), such as in a car parked in the sun or under direct sunlight [b].
- Do not place your camcorder so as to point the viewfinder or the LCD screen toward the sun. The inside of the viewfinder or LCD screen may be damaged [c].

[a]

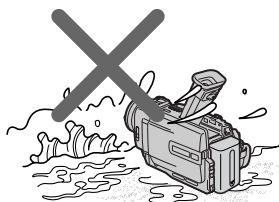

[b]

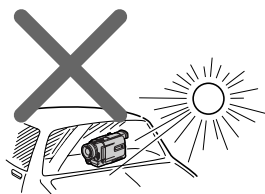

[c]

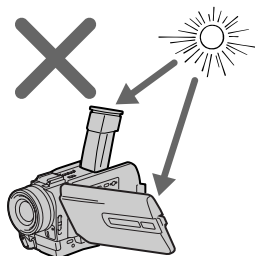

Contents of the recording cannot be compensated if recording or playback is not made due to a malfunction of the camcorder, video tape, etc.

Step 1 Preparing the power supply

Installing the battery pack

Install the battery pack to use your camcorder outdoors.

- (1) Lift up the viewfinder.
- (2) Slide the battery pack down until it clicks.

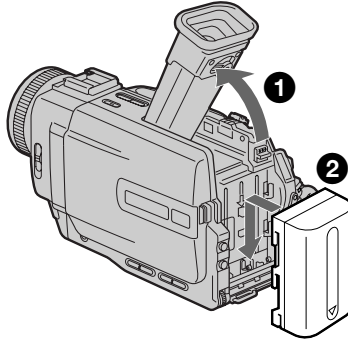

To remove the battery pack

- (1) Lift up the viewfinder.
- (2) Slide the battery pack out in the direction of the arrow while pressing BATT down.

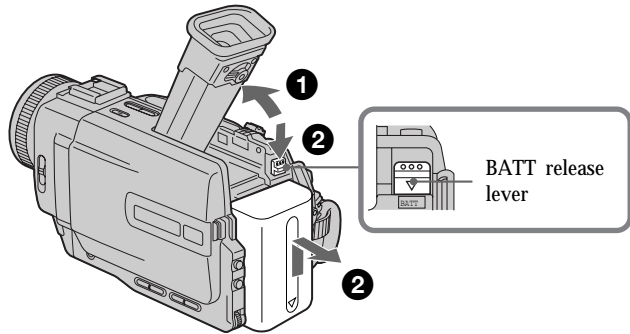

After installing the battery pack

Do not carry your camcorder by holding the battery pack. If you do so, the battery pack may slide off your camcorder unintentionally, damaging your camcorder.

If you use the large capacity battery pack

If you install the NP-FM70/FM90/FM91 battery pack on your camcorder, extend its viewfinder. Take care not to pinch your finger when lifting the viewfinder up and down.

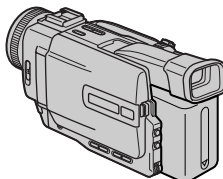

Step 1 Preparing the power supply

Charging the battery pack

Use the battery pack after charging it for your camcorder.

Your camcorder operates only with the “InfoLITHIUM” battery pack (M series).

- (1) Open the DC IN jack cover, pulling the cover out a little and rotating. Connect the AC power adaptor supplied with your camcorder to the DC IN jack on your camcorder with the plug's ▲ mark facing the lens side.
- (2) Connect the power cord to the AC power adaptor.
- (3) Connect the power cord to the wall outlet.
- (4) Set the POWER switch to OFF (CHG). Charging begins. The remaining battery time is indicated in minutes on the display window.

When the remaining battery indicator changes to , normal charge is completed. To fully charge the battery (full charge), leave the battery pack attached for about one hour after normal charge is completed until FULL appears in the display window. Fully charging the battery allows you to use the battery longer than usual.

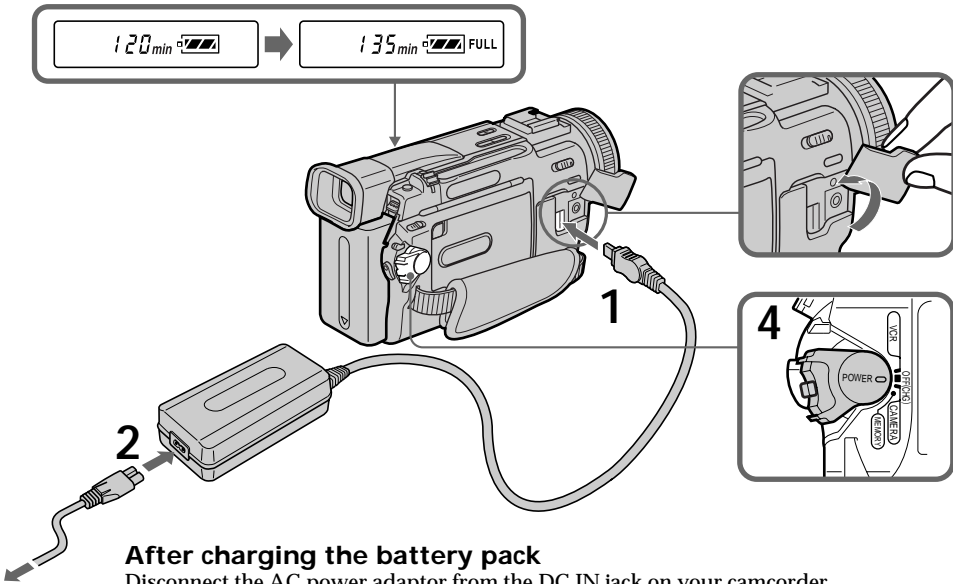

After charging the battery pack

Disconnect the AC power adaptor from the DC IN jack on your camcorder.

Notes

- Prevent metallic objects from coming into contact with the metal parts of the DC plug of the AC power adaptor. This may cause a short-circuit, damaging the AC power adaptor.
- Keep the battery pack dry.
- When the battery pack is not to be used for a long time, charge the battery pack once fully and then use it until it fully discharges again. Keep the battery pack in a cool place.

Remaining battery time indicator

The remaining battery time you record with the viewfinder is displayed.

The remaining battery time indicator in the display window roughly indicates the recording time with the viewfinder.

Battery pack

The battery pack is charged a little before it leaves the factory.

Step 1 Preparing the power supply

Until your camcorder calculates the actual remaining battery time
“--- min” appears in the display window.

While charging the battery pack, no indicator appears or the indicator flashes in the display window in the following cases:

- The battery pack is not installed correctly.
- The AC power adaptor is disconnected.
- Something is wrong with the battery pack.

Charging time

Battery pack	Full charge (Normal charge)
NP-FM50 (supplied)	150 (90)
NP-FM70	240 (180)
NP-FM90	330 (270)
NP-FM91	360 (300)

Approximate minutes to charge an empty battery pack

Recording time

DCR-TRV6

Battery pack	Recording with the viewfinder		Recording with the LCD screen	
	Continuous*	Typical**	Continuous*	Typical**
NP-FM50 (supplied)	200 (180)	110 (95)	145 (130)	75 (70)
NP-FM70	415 (375)	225 (205)	305 (270)	165 (145)
NP-FM90	630 (565)	345 (310)	460 (410)	250 (225)
NP-FM91	725 (655)	395 (360)	535 (480)	290 (260)

DCR-TRV11

Battery pack	Recording with the viewfinder		Recording with the LCD screen	
	Continuous*	Typical**	Continuous*	Typical**
NP-FM50 (supplied)	195 (175)	105 (95)	140 (125)	75 (65)
NP-FM70	400 (360)	220 (195)	295 (265)	160 (145)
NP-FM90	600 (540)	330 (295)	450 (400)	245 (220)
NP-FM91	695 (625)	380 (340)	520 (465)	285 (255)

DCR-TRV20

Battery pack	Recording with the viewfinder		Recording with the LCD screen	
	Continuous*	Typical**	Continuous*	Typical**
NP-FM50 (supplied)	135 (120)	80 (70)	105 (95)	60 (55)
NP-FM70	275 (250)	165 (150)	225 (205)	135 (120)
NP-FM90	425 (380)	255 (225)	345 (310)	205 (185)
NP-FM91	490 (440)	290 (260)	400 (360)	240 (215)

Approximate minutes when you use a fully charged battery

Step 1 Preparing the power supply

Numbers in parentheses “()” indicate the time using a normally charged battery.

* Approximate continuous recording time at 77°F (25°C). The battery life will be shorter if you use your camcorder in a cold environment.

** Approximate number of minutes when recording while you repeat recording start/stop, zooming and turning the power on/off. The actual battery life may be shorter.

Playing time

DCR-TRV6

Battery pack	Playing time on LCD screen	Playing time with LCD closed
NP-FM50 (supplied)	145 (130)	200 (180)
NP-FM70	305 (270)	415 (375)
NP-FM90	460 (410)	630 (565)
NP-FM91	535 (480)	725 (655)

DCR-TRV11

Battery pack	Playing time on LCD screen	Playing time with LCD closed
NP-FM50 (supplied)	140 (125)	195 (175)
NP-FM70	295 (265)	400 (360)
NP-FM90	450 (400)	600 (540)
NP-FM91	520 (465)	695 (625)

DCR-TRV20

Battery pack	Playing time on LCD screen	Playing time with LCD closed
NP-FM50 (supplied)	125 (110)	160 (145)
NP-FM70	265 (235)	335 (300)
NP-FM90	400 (360)	505 (455)
NP-FM91	465 (415)	585 (525)

Approximate minutes when you use a fully charged battery

Numbers in parentheses “()” indicate the time using a normally charged battery. The battery life will be shorter if you use your camcorder in a cold environment.

What is “InfoLITHIUM”?

The “InfoLITHIUM” is a lithium ion battery pack which can exchange data such as battery consumption with compatible electronic equipment. This unit is compatible with the “InfoLITHIUM” battery pack (M series). Your camcorder operates only with the “InfoLITHIUM” battery. “InfoLITHIUM” M series battery packs have the

 mark.

“InfoLITHIUM” is a trademark of Sony Corporation.

Step 1 Preparing the power supply

Connecting to a wall outlet

When you use your camcorder for a long time, we recommend that you power it from a wall outlet using the AC power adaptor.

- (1) Open the DC IN jack cover, pulling the cover out a little and rotating it.
Connect the AC power adaptor supplied with your camcorder to the DC IN jack on your camcorder with the plug's ▲ mark facing the lens side.
- (2) Connect the power cord to the AC power adaptor.
- (3) Connect the power cord to a wall outlet.

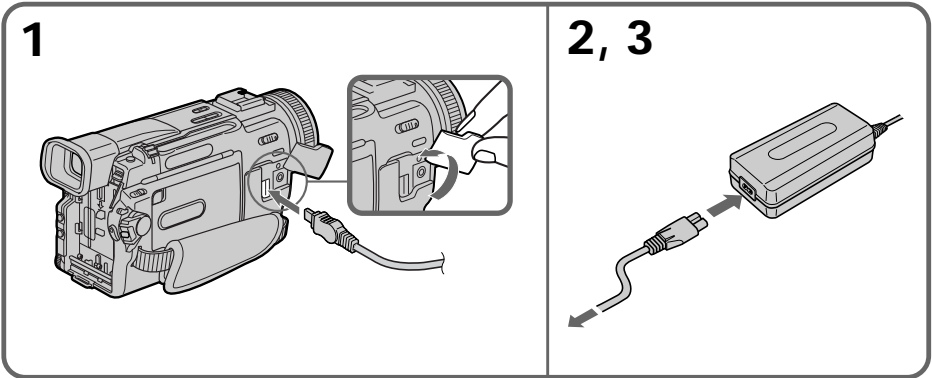

PRECAUTION

The set is not disconnected from the AC power source (house current) as long as it is connected to the wall outlet, even if the set itself has been turned off.

Notes

- The AC power adaptor can supply power even if the battery pack is attached to your camcorder.
- The DC IN jack has “source priority.” This means that the battery pack cannot supply any power if the power cord is connected to the DC IN jack, even when the power cord is not plugged into a wall outlet.

Using a car battery

Use Sony DC Adaptor/Charger (not supplied).

Step 2 Inserting a cassette

- (1) Install the power source.
- (2) Slide OPEN/EJECT in the direction of the arrow and open the lid. The cassette compartment automatically lifts up and opens.
- (3) Push the middle portion of the back of the cassette to insert. Insert the cassette in a straight line deeply into the cassette compartment with the window facing out.
- (4) Close the cassette compartment by pressing the **PUSH** mark on the cassette compartment. The cassette compartment automatically goes down.
- (5) After the cassette compartment going down completely, close the lid until it clicks.

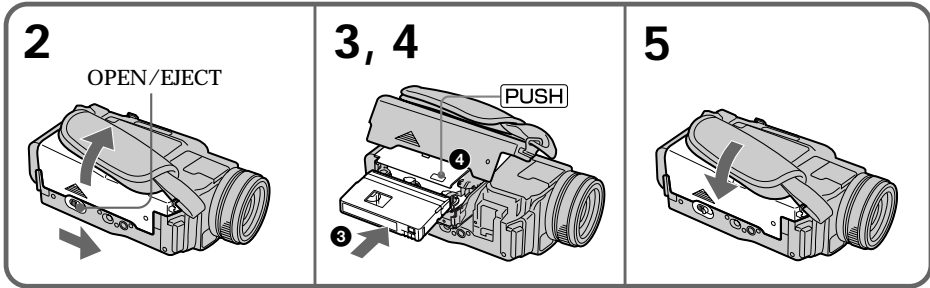

To eject a cassette

Follow the procedure above, and take out the cassette in step 3.

Notes

- Do not press the cassette compartment down. Doing so may cause malfunction.
- The cassette compartment may not be closed when you press any part of the lid other than the **PUSH** mark.

When you use mini DV cassette with cassette memory

Read the instruction about cassette memory to use this function properly (p. 124).

To prevent accidental erasure

Slide the write-protect tab on the cassette to expose the red mark.

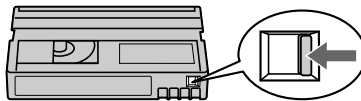

Recording a picture

Your camcorder automatically focuses for you.

- (1) Remove the lens cap by pressing both knobs on its sides and attach the lens cap to the grip strap.
- (2) Install the power source and insert a cassette. See “Step 1” and “Step 2” for more information (p. 10 to p. 15).
- (3) Set the POWER switch to CAMERA while pressing the small green button. Your camcorder is set to the standby mode.
- (4) To open the LCD panel, press OPEN. The viewfinder automatically turns off.
- (5) Press START/STOP. Your camcorder starts recording. The “REC” indicator appears. The camera recording lamp located on the front of your camcorder lights up. To stop recording, press START/STOP again.

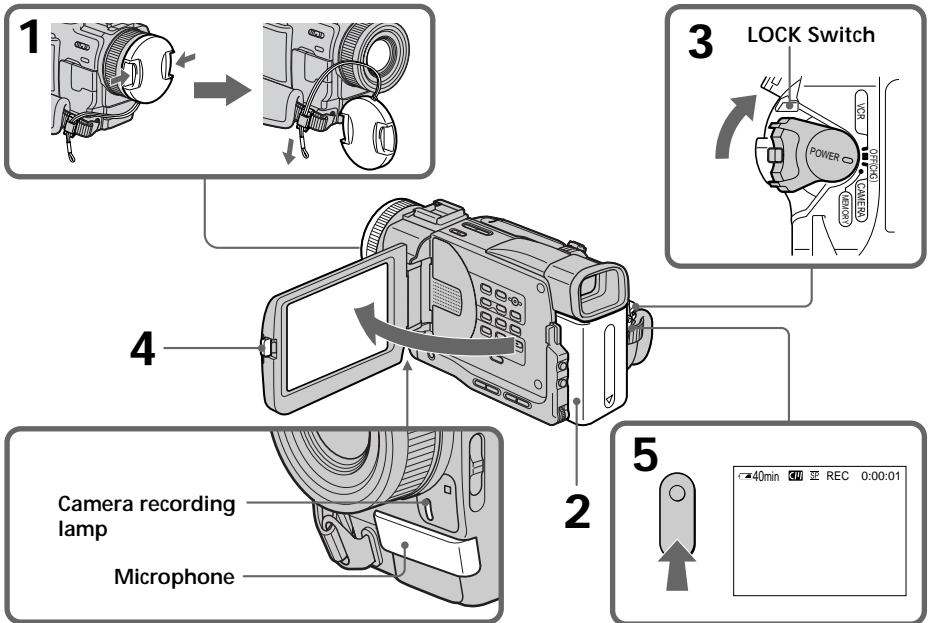

Note

Fasten the grip strap firmly.

Note on Recording mode

Your camcorder records and plays back in the SP (standard play) mode and in the LP (long play) mode. Select SP or LP in the menu settings. In the LP mode, you can record 1.5 times as long as in the SP mode.

When you record a tape in the LP mode on your camcorder, we recommend playing the tape on your camcorder.

Recording a picture

Note on the LOCK switch (DCR-TRV11/TRV20 only)

When you slide the LOCK switch to the right, the POWER switch can no longer be set to MEMORY accidentally. LOCK switch is set to the left before your camcorder leaves the factory.

To enable smooth transition

Transition between the last scene you recorded and the next scene is smooth as long as you do not eject the cassette even if you turn off your camcorder.

However, check the following:

- Do not mix recordings in the SP mode and ones in the LP mode on one tape.
- When you change the battery pack, set the POWER switch to OFF (CHG).

When you use a tape with cassette memory, however, you can make the transition smooth even after ejecting the cassette if you use the END SEARCH function (p. 24).

If you leave your camcorder in the standby mode for five minutes while the cassette is inserted

Your camcorder automatically turns off. This is to save battery power and to prevent battery and tape wear. To resume the standby mode, set the POWER switch to OFF (CHG), and to CAMERA again.

When you record in the SP and LP modes on one tape or you record some scenes in the LP mode

The playback picture may be distorted or the time code may not be written properly between scenes.

Adjusting the LCD screen

The LCD panel moves about 90 degrees to the viewfinder side and about 180 degrees to the lens side.

If you turn the LCD panel over so that it faces the other way, the ☺ indicator appears on the LCD screen and in the viewfinder (**Mirror mode**).

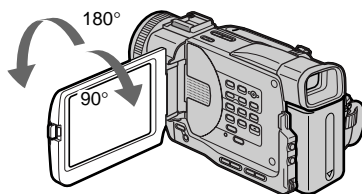

When closing the LCD panel, set it vertically until it clicks, and swing it into the camcorder body.

Note

When using the LCD screen except in the mirror mode, the viewfinder automatically turns off.

Recording a picture

When you use the LCD screen outdoors in direct sunlight

The LCD screen may be difficult to see. If this happens, we recommend that you use the viewfinder.

Picture in the mirror mode

The picture on the LCD screen is a mirror-image. However, the picture will be normal when recorded.

During recording in the mirror mode

ZERO SET MEMORY on the Remote Commander does not work.

Indicators in the mirror mode

The STBY indicator appears as **II●** and REC as **●**. Some of the other indicators appear mirror-reversed and others are not displayed.

Adjusting the brightness of the LCD screen

To adjust the brightness of the LCD screen, press either of the two buttons on LCD BRIGHT.

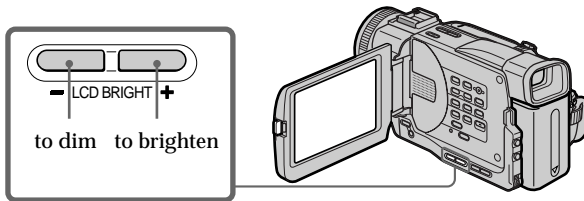

LCD screen backlight

You can change the brightness of the backlight. Select LCD B.L. in the menu settings (p. 85).

Even if you adjust the LCD screen backlight or brightness of the LCD screen

The recorded picture will not be affected.

After recording

- (1) Set the POWER switch to OFF (CHG).
- (2) Close the LCD panel.
- (3) Eject the cassette.

Recording a picture

Adjusting the viewfinder

If you record pictures with the LCD panel closed, check the picture with the viewfinder. Adjust the viewfinder lens to your eyesight so that the indicators in the viewfinder come into sharp focus.

Lift up the viewfinder and move the viewfinder lens adjustment lever.

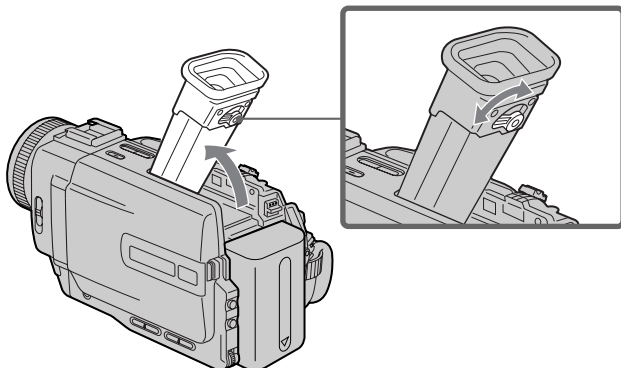

Viewfinder backlight

You can change the brightness of the backlight. Select VF B.L. in the menu settings. (p.85)

Attaching the supplied lens hood (DCR-TRV20 only)

To record fine pictures under strong light, we recommend attaching the lens hood. Also the lens cap can be attached even with the lens hood on.

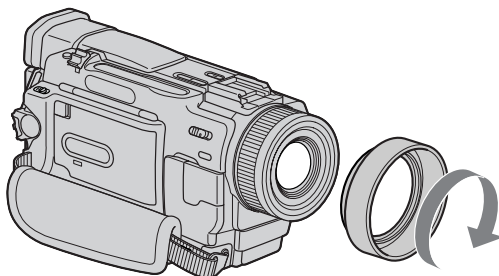

Notes

- When you use the Remote Commander and the lens hood, the Remote Commander may not function properly because the lens hood blocks the infrared rays from the Remote Commander. In such case, remove the lens hood from your camcorder.
- You cannot attach filters or other objects onto the lens hood.

When you use the filter (not supplied)

The shadow of the lens hood may appear in the corners of LCD screen or viewfinder.

Recording a picture

Using the zoom feature

Move the power zoom lever a little for a slower zoom. Move it further for a faster zoom. Using the zoom function sparingly results in better-looking recordings.

“T” side: for telephoto (subject appears closer)

“W” side: for wide-angle (subject appears farther away)

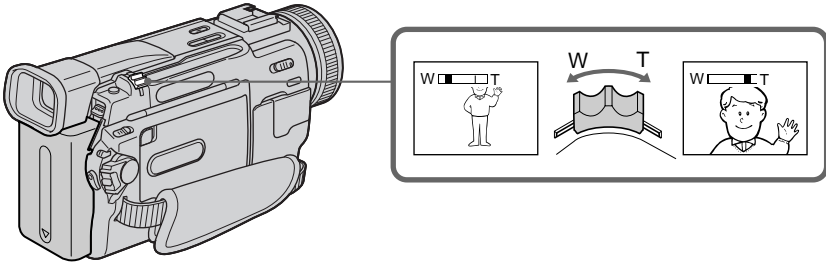

To use zoom greater than 10×

Zoom greater than 10× is performed digitally, if you set D ZOOM to 20× or 120× in the menu settings. The digital zoom function is set to OFF at the factory. (p. 85)

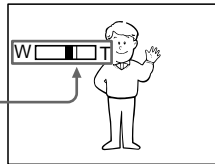

The right side of the bar shows the digital zooming zone.

The digital zooming zone appears when you set D ZOOM to 20× or 120×.

When you shoot close to a subject

If you cannot get a sharp focus, move the power zoom lever to the “W” side until the focus is sharp. You can shoot a subject that is at least about 2 feet 5/8 inch (about 80 cm) away from the lens surface in the telephoto position, or about 1/2 inch (about 1 cm) away in the wide-angle position.

Notes on digital zoom

- Digital zoom starts to function when zoom exceeds 10×.
- The picture quality deteriorates as you move the power zoom lever toward the “T” side.
- You cannot use the digital zoom when the POWER switch is set to MEMORY (DCR-TRV11/TRV20 only).

Recording a picture

Indicators displayed in the recording mode

The indicators are not recorded on tapes.

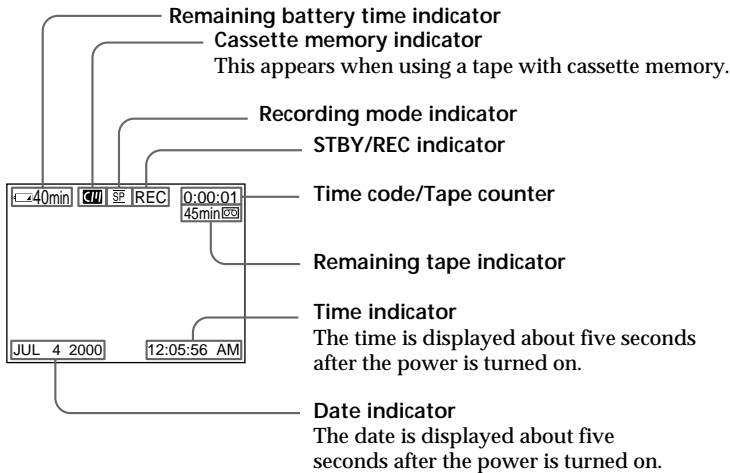

Time code

The time code indicates the recording or playback time, "0:00:00" (hours : minutes : seconds) in CAMERA mode and "0:00:00:00" (hours : minutes : seconds : frames) in VCR mode. You cannot rewrite only the time code.

Remaining tape indicator

The indicator may not be displayed accurately depending on the tape.

Recording date and time

The recording date and time are not displayed while recording. However, they are recorded automatically onto the tape. To display the recording date and time, press DATE CODE during playback.

Shooting backlit subjects (BACK LIGHT)

When you shoot a subject with the light source behind the subject or a subject with a light background, use the backlight function.

In the standby, recording or memory mode, press BACK LIGHT.

The  indicator appears in the viewfinder or on the LCD screen.

To cancel, press BACK LIGHT again.

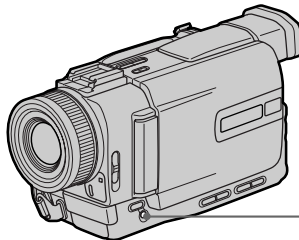

BACK LIGHT

If you press EXPOSURE when shooting backlit subjects

The backlight function will be canceled.

Recording a picture

Shooting in the dark (NightShot/Super NightShot)

The NightShot function enables you to shoot a subject in a dark place. For example, you can satisfactorily record the environment of nocturnal animals for observation when you use this function.

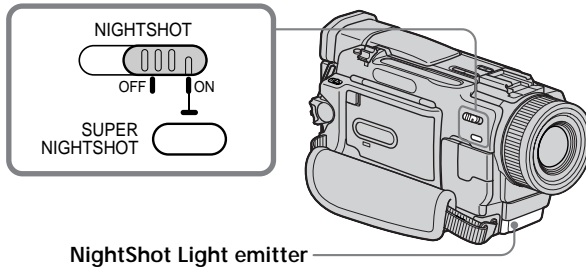

In the standby, recording or memory mode, slide NIGHTSHOT to ON.

 and “NIGHTSHOT” indicators flash on the LCD screen or in the viewfinder. To cancel the NightShot function, slide NIGHTSHOT to OFF.



Using Super NightShot

The Super NightShot mode makes subjects more than 16 times brighter than those recorded in the NightShot mode

- (1) In the standby or recording mode, slide NIGHTSHOT to ON.  indicator appears on the LCD screen or in the viewfinder.
- (2) Press SUPER NIGHTSHOT. The  indicator and “SUPER NIGHTSHOT” appear.
To cancel the Super NightShot mode, press SUPER NIGHTSHOT.

Using the NightShot Light

The picture will be clearer with the NightShot Light on. To enable NightShot Light, set N.S. LIGHT to ON in the menu settings (p. 85).

Notes

- Do not use the NightShot function in bright places (ex. the outdoors in the daytime). This may cause your camcorder to malfunction.
- When you keep NIGHTSHOT set to ON in normal recording, the picture may be recorded in incorrect or unnatural colors.
- If focusing is difficult with the autofocus mode when using the NightShot function, focus manually.

While using the NightShot function, you cannot use the following functions:

- Exposure
- PROGRAM AE
- White balance

While using the Super NightShot function

The shutter speed is automatically adjusted depending on the brightness. At that time, the moving picture may be slow down.

Recording a picture

While using the Super NightShot function, you cannot use the following functions:

- Exposure
- PROGRAM AE
- Fader
- Digital effect
- Memory mode (DCR-TRV11/TRV20 only)

NightShot Light

NightShot Light rays are infrared and so are invisible. The maximum shooting distance using the NightShot Light is about 10 feet (3 m).

Self-timer recording

You can make a recording with the self-timer. This mode is useful when you want to record yourself.

- (1) Press SELFTIMER in the standby mode. The  (self-timer) indicator appears on the LCD screen or in the viewfinder.
- (2) Press START/STOP.
Self-timer starts counting down from 10 with a beep sound. In the last two seconds of the countdown, the beep sound gets faster, then recording starts automatically.

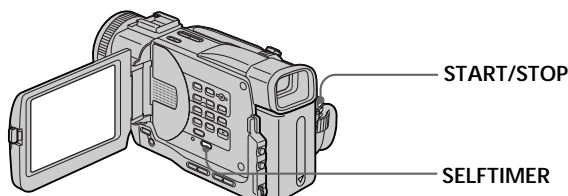

To stop the self-timer before recording

Press START/STOP again.

Use the Remote Commander for convenience.

To record still pictures on tapes using the self-timer

Press PHOTO in step 2 (p. 31).

To record still pictures on "Memory Stick"s

Press SELFTIMER, then press PHOTO in MEMORY mode (p. 104).

To cancel self-timer recording

Press SELFTIMER so that the  indicator disappears from on the LCD screen or in the viewfinder while your camcorder is in the standby mode.

Note

The self-timer recording mode is automatically canceled when:

- Self-timer recording is finished.
- The POWER switch is set to OFF (CHG) or VCR.

Checking the recording – END SEARCH / EDITSEARCH /

Rec Review

You can use these buttons to check the recorded picture or shoot so that the transition between the last recorded scene and the next scene you record is smooth.

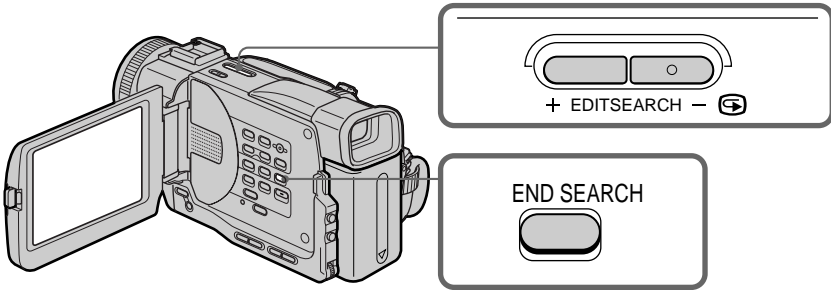

END SEARCH

You can go to the end of the recorded section after you record.

Press END SEARCH in the standby mode.

The last five seconds of the recorded section are played back and playback stops. You can monitor the sound from the speaker or headphones.

EDITSEARCH

You can search for the next recording start point.

Hold down the +/-  side of EDITSEARCH in the standby mode. The recorded section is played back.

+ : to go forward

-  : to go backward

Release EDITSEARCH to stop playback. If you press START/STOP, re-recording begins from the point you released EDITSEARCH. You cannot monitor the sound.

Rec Review

You can check the last recorded section.

Press the -  side of EDITSEARCH momentarily in the standby mode.

The last few seconds of the selected section are played back. You can monitor the sound from the speaker or headphones.

End search function

When you use a tape without cassette memory, the end search function does not work once you eject the cassette after you have recorded on the tape. If you use a tape with cassette memory, the end search function works even once you eject the cassette.

If there is a blank portion in the recorded portion, the end search function may not work correctly (p. 124).

Playing back a tape

You can monitor the playback picture on the LCD screen. If you close the LCD panel, you can monitor the playback picture in the viewfinder. You can control playback using the Remote Commander supplied with your camcorder.

- (1) Install the power source and insert the recorded tape.
- (2) Set the POWER switch to VCR while pressing the small green button. The video control buttons light up.
- (3) To open the LCD panel, press OPEN.
- (4) Press ◀◀ to rewind the tape.
- (5) Press ▶ to start playback.
- (6) To adjust the volume, press either of the two buttons on VOLUME. The speaker on your camcorder is silent when the LCD panel is closed.

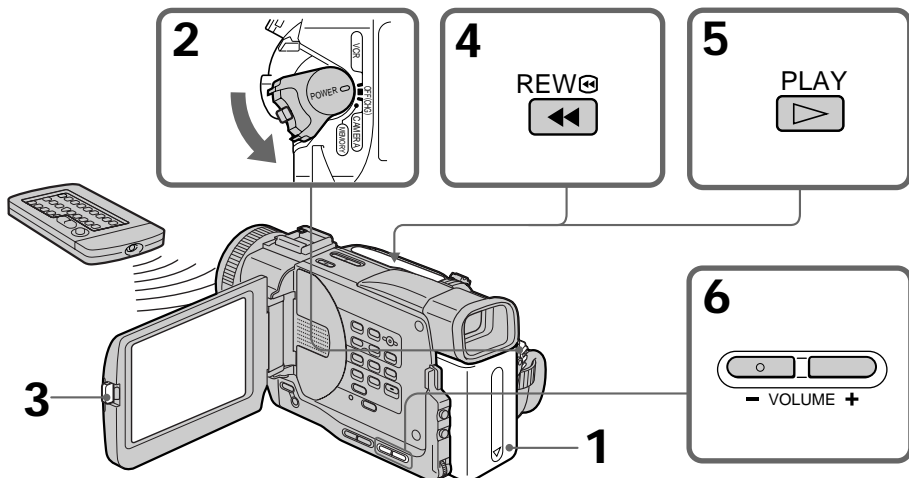

To stop playback

Press ■.

When monitoring on the LCD screen

You can turn the LCD panel over and move it back to the camcorder body with the LCD screen facing out.

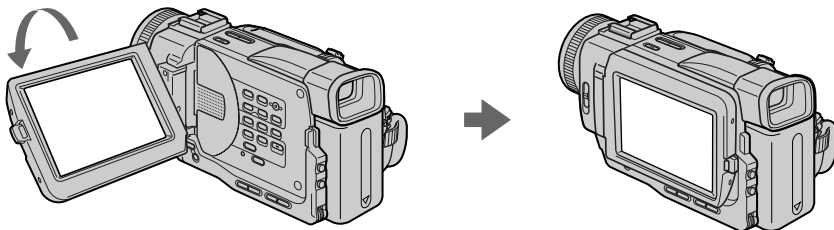

Playing back a tape

To display the screen indicators – Display function

Press DISPLAY on your camcorder or the Remote Commander supplied with your camcorder.

The indicators appear on the LCD screen.

To make the indicators disappear, press DISPLAY again.

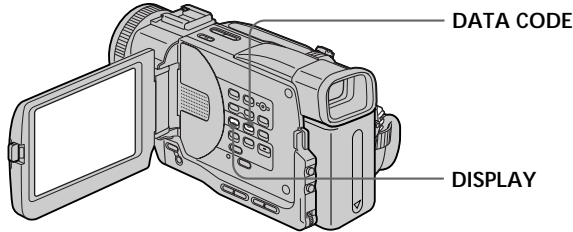

Using the data code function

Your camcorder automatically records not only images on the tape but also the recording data (date/time or various settings when recorded) (Data code).

Press DATA CODE on your camcorder or the Remote Commander in the playback mode.

The display changes as follows:

date/time → various settings (SteadyShot, white balance, gain, shutter speed, aperture value, exposure mode) → no indicator

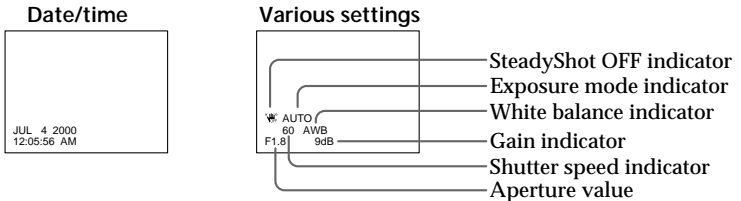

Not to display various settings

Set DATA CODE to DATE in the menu settings (p. 85).

The display changes as follows:

date/time ↔ no indicator

Recording data

Recording data is your camcorder's information when you have recorded. In the recording mode, the recording data will not be displayed.

When you use the data code function, bars (---) appear if:

- A blank portion of the tape is being played back.
- The tape is unreadable due to tape damage or noise.
- The tape was recorded by a camcorder without the date and time set.

Data code

The data code is displayed on the TV screen if you connect your camcorder to the TV (p. 28).

Various playback modes

To operate video control buttons, set the POWER switch to VCR.

To view a still picture (playback pause)

Press **II** during playback. To resume normal playback, press **▶** or **II**.

To advance the tape

Press **▶▶** in the stop mode. To resume normal playback, press **▶**.

To rewind the tape

Press **◀◀** in the stop mode. To resume normal playback, press **▶**.

To change the playback direction

Press **<** on the Remote Commander during playback to reverse the playback direction. To resume normal playback, press **▶**.

To locate a scene monitoring the picture (picture search)

Keep pressing **◀◀** or **▶▶** during playback. To resume normal playback, release the button.

To monitor the high-speed picture while advancing or rewinding the tape (skip scan)

Keep pressing **◀◀** while rewinding or **▶▶** while advancing the tape. To resume rewinding or advancing, release the button.

To view the picture at slow speed (slow playback)

Press **▶** on the Remote Commander during playback. For slow playback in the reverse direction, press **<**, then press **▶** on the Remote Commander. To resume normal playback, press **▶**.

To view the picture at double speed

Press **×2** on the Remote Commander during playback. For double speed playback in the reverse direction, press **<**, then press **×2** on the Remote Commander. To resume normal playback, press **▶**.

To view the picture frame-by-frame

Press **II▶** on the Remote Commander in the playback pause mode. For frame-by-frame playback in the reverse direction, press **◀II**. To resume normal playback, press **▶**.

To search the last scene recorded (END SEARCH)

Press **END SEARCH** in the stop mode. The last five seconds of the recorded portion plays back and stops.

End Search

When you use a tape without cassette memory, the end search function does not work once you eject the cassette after you have recorded on the tape.

When you use a tape with cassette memory, the end search function works even once you eject the cassette.

In the various playback modes

- Sound is muted.
- The previous picture may remain as a mosaic image during playback.

When the playback pause mode lasts for five minutes

Your camcorder automatically enters the stop mode. To resume playback, press **▶**.

Slow playback

The slow playback can be performed smoothly on your camcorder; however, this function does not work for an output signal through the **■** DV IN/OUT jack.

When you play back a tape in reverse

Horizontal noise may appear at the center, or the top and bottom of the screen. This is not a malfunction.

Viewing the recording on TV

Connect your camcorder to your TV or VCR with the A/V connecting cable supplied with your camcorder to watch the playback picture on the TV screen. You can operate the video control buttons in the same way as when you monitor playback pictures on the LCD screen. When monitoring the playback picture on the TV screen, we recommend that you power your camcorder from a wall outlet using the AC power adaptor (p. 14). Refer to the operating instructions of your TV or VCR.

Open the jack cover. Connect your camcorder to the TV using the A/V connecting cable supplied with your camcorder. Then, set the TV/VCR selector on the TV to VCR.

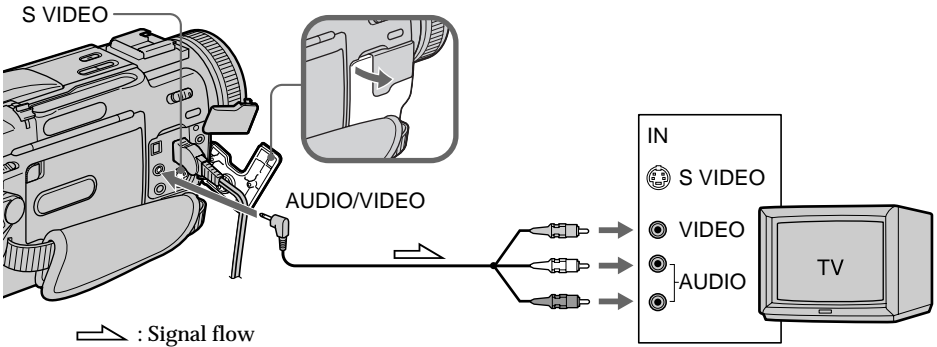

If your TV is already connected to a VCR

Connect your camcorder to the LINE IN input on the VCR by using the A/V connecting cable supplied with your camcorder. Set the input selector on the VCR to LINE.

If your TV or VCR is a monaural type

Connect the yellow plug of the A/V connecting cable to the video input jack and the white or the red plug to the audio input jack on the VCR or the TV. If you connect the white plug, the sound is L (left) signal. If you connect the red plug, the sound is R (right) signal.

If your TV or VCR has an S video jack

Connect using an S video cable (not supplied) to obtain high-quality pictures. With this connection, you do not need to connect the yellow (video) plug of the A/V connecting cable.

Connect the S video cable (not supplied) to the S video jacks on both your camcorder and the TV or the VCR.

This connection produces higher quality DV format pictures.

Viewing the recording on TV

Using the AV cordless IR receiver

Once you connect the AV cordless IR receiver (not supplied) to your TV or VCR, you can easily view the picture on your TV. For details, refer to the operating instructions of the AV cordless IR receiver.

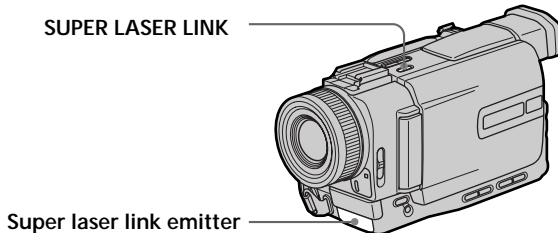

Insert a tape into your camcorder.

- (1) After connecting your TV and AV cordless IR receiver, set the POWER switch on the AV cordless IR receiver to ON.
- (2) Set the POWER switch to VCR.
- (3) Turn the TV on and set the TV/VCR selector on the TV to VCR.
- (4) Press SUPER LASER LINK. The lamp of SUPER LASER LINK lights up.
- (5) Press ► on your camcorder to start playback.
- (6) Point the super laser link emitter at the AV cordless IR receiver. Adjust the position of your camcorder and the AV cordless IR receiver to obtain clear playback pictures.

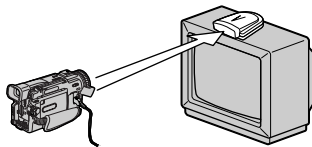

To cancel the super laser link function

Press SUPER LASER LINK again. The lamp on the SUPER LASER LINK button goes out.

If you turn the power off

The super laser link function turns off automatically.

If you use a Sony TV

- You can turn on the TV automatically when you press SUPER LASER LINK. To do so, make sure you:
 - Turn the TV's main switch on.
 - Set AUTO TV ON to ON in the menu settings.
 - Point the super laser link emitter at the TV's remote sensor.
- You can switch the video input of the TV automatically to the one which the AV cordless IR receiver is connected. To do so, set AUTO TV ON to ON and TV INPUT to the same video input (1, 2, 3) in the menu settings. With some models, however, the picture and sound may be disconnected momentarily when the video input is switched.
- The above feature may not work on some TV models.

When the super laser link is activated (the SUPER LASER LINK button is lit)

Your camcorder consumes power. Press SUPER LASER LINK to turn off the laser link function when it is not needed.



is a trademark of Sony Corporation.

Recording a still image on a tape - Tape Photo recording

You can record a still picture, for example, a photograph or drawing. This mode is useful when you want to print a picture using a video printer (not supplied).

You can record about 510 pictures in the SP mode and about 765 pictures in the LP mode on a 60-minute tape.

Besides the operation described here, your camcorder can record still pictures on “Memory Stick”s (p. 100) (DCR-TRV11/TRV20 only).

(1) Set the POWER switch to CAMERA.

(2) In the standby mode, keep pressing PHOTO lightly until a still picture appears.

The CAPTURE indicator appears. Recording does not start yet.

To change the still picture, release PHOTO, select a still picture again, and then press and hold PHOTO lightly.

(3) Press PHOTO deeper.

The still picture on the LCD screen or in the viewfinder is recorded for about seven seconds. The sound during those seven seconds is also recorded.

The still image is displayed on the LCD screen or in the viewfinder until recording is completed.

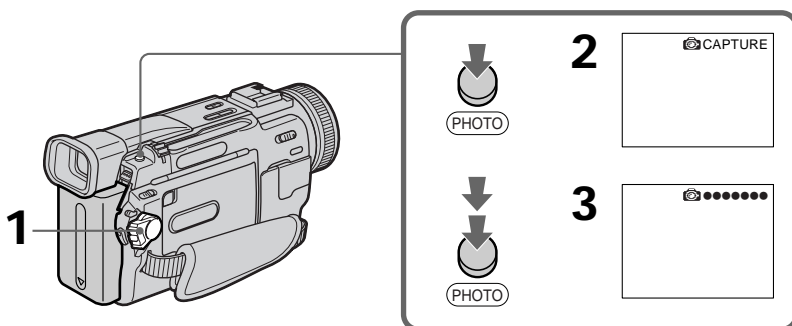

Notes

- During tape photo recording, you cannot change the mode or setting.
- When recording a still picture, do not shake your camcorder. The picture may fluctuate.
- The PHOTO button does not work:
 - while the fader function is set or in use
 - while the digital effect function is set or in use

If you record a moving subject with tape photo recording function

When you play back the still picture on other equipment, the picture may fluctuate.

To use the tape photo recording function using the Remote Commander

Press PHOTO on the Remote Commander. Your camcorder records a picture on the LCD screen or in the viewfinder immediately.

To use the tape photo recording function during normal CAMERA recording

Press PHOTO deeper. The still picture is then recorded for about seven seconds and your camcorder returns to the standby mode. You cannot select another still picture.

To record clear and less fluctuated still pictures

We recommend that you record on “Memory Stick”s. (DCR-TRV11/TRV20 only)

Recording a still image on a tape – Tape Photo recording

Self-timer tape photo recording

You can make a tape photo recording with the self-timer. This mode is useful when you want to record yourself.

- (1) Set the POWER switch to CAMERA.
- (2) Press SELFTIMER. The  (self-timer) indicator appears on the LCD screen or in the viewfinder.
- (3) Press PHOTO deeper.

Self-timer starts counting down from 10 with a beep sound. In the last two seconds of the countdown, the beep sound gets faster, then recording starts automatically.

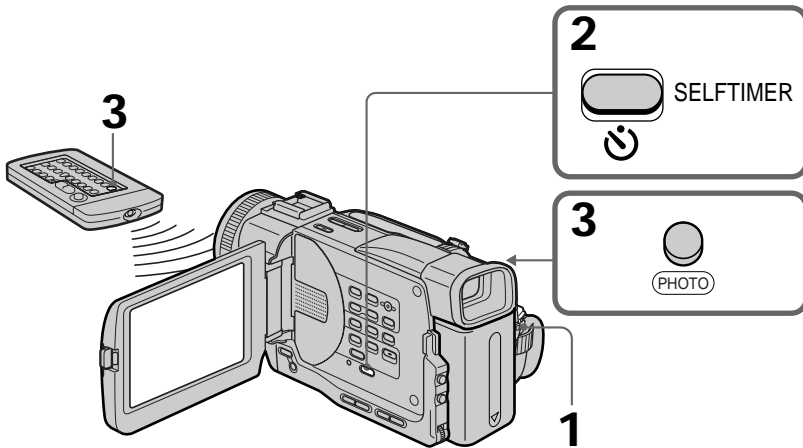

To cancel self-timer tape photo recording

Press SELFTIMER so that the  indicator disappears from the LCD screen or in the viewfinder while your camcorder is in the standby mode. You cannot cancel the self-timer tape photo recording using the Remote Commander.

Note

The self-timer tape photo recording mode is automatically canceled when:

- Self-timer tape photo recording is finished.
- The POWER switch is set to OFF or VCR.

Recording a still image on a tape – Tape Photo recording

Printing the still picture

You can print a still picture by using the video printer (not supplied). Connect the video printer using the A/V connecting cable supplied with your camcorder. Connect it to the AUDIO/VIDEO jack and connect the yellow plug of the cable to the video input of the video printer. Refer to the operating instructions of the video printer as well.

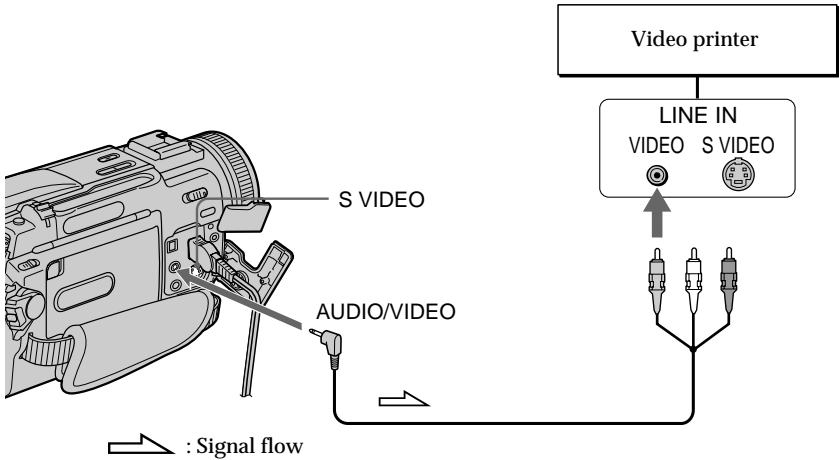

If the video printer is equipped with S video input

Use the S video connecting cable (not supplied). Connect it to the S VIDEO jack and the S video input of the video printer.

Adjusting the white balance manually

You can manually adjust and set the white balance. This adjustment makes white subjects look white and allows more natural color balance. Normally white balance is automatically adjusted.

In the standby, recording or memory mode, select a desired white balance mode in  in the menu settings (p. 85).

 (INDOOR) :

- Lighting condition changes quickly
- Too bright place such as photography studios
- Under sodium lamps or mercury lamps

 (OUTDOOR) :

- Recording a sunset/sunrise, just after sunset, just before sunrise, neon signs, or fireworks
- Under a color matching fluorescent lamp

HOLD :

Recording a single-colored subject or background

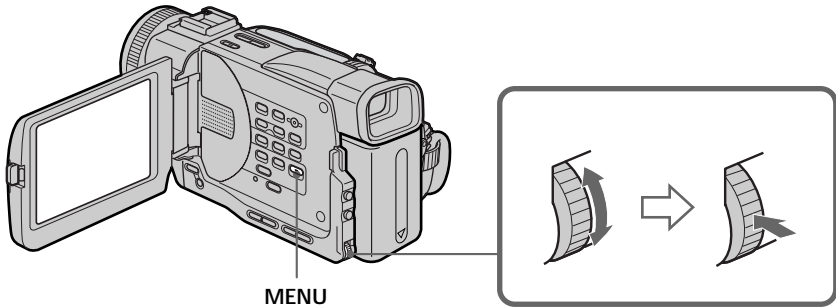

To return to the automatic white balance mode

Set WHT BAL to AUTO in the menu settings.

If the picture is being taken in a studio lit by TV lighting

We recommend that you record in the  indoor mode.

When you record under fluorescent lighting

Use the automatic white balance or hold mode.

Your camcorder may not adjust the white balance correctly in the  indoor mode.

In the automatic white balance mode

Point your camcorder at a white subject for about 10 seconds after setting the POWER switch to CAMERA to get a better adjustment when:

- You detach the battery for replacement.
- You bring your camcorder to the outdoors from the interior of a house, or vice versa.

In the hold white balance mode

Set the white balance to AUTO and reset to HOLD after a few seconds when:

- You change the PROGRAM AE mode.
- You bring your camcorder to the outdoors from the interior of a house, or vice versa.

Using the wide mode

You can record a 16:9 wide picture to watch on the 16:9 wide-screen TV (16:9WIDE). Black bands appear on the screen during recording in 16:9WIDE mode [a]. The picture during a playback on a normal TV [b] or on a wide-screen TV [c] is compressed in the widthwise direction. If you set the screen mode of the wide-screen TV to the full mode, you can watch pictures of normal images [d].

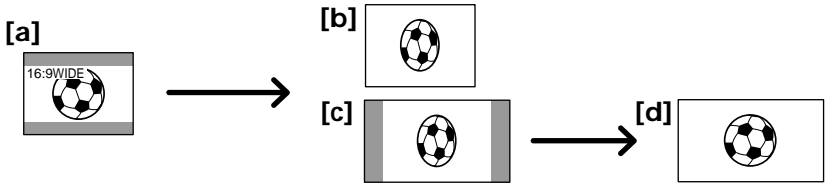

In the standby mode, set 16:9WIDE to ON in  in the menu settings (p. 85).

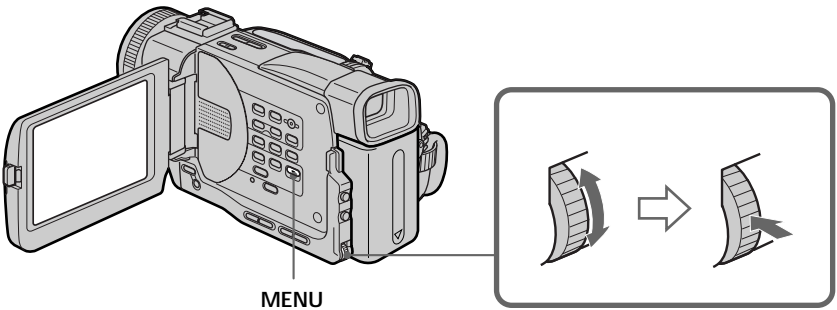

To cancel the wide mode

Set 16:9WIDE to OFF in the menu settings.

In the wide mode, you cannot select the following functions:

- Old movie
- Bounce (DCR-TRV6/TRV11 only)

During recording

You cannot select or cancel the wide mode. When you cancel the wide mode, set your camcorder to the standby mode and then set 16:9WIDE to OFF in the menu settings.

Connection for a TV

Pictures recorded in the 16:9WIDE mode automatically appear on the TV screen at full size when you connect your camcorder to a TV that is compatible with the video ID (ID-1/ID-2) system.

ID-1 system

The ID-1 system sends aspect ratio information (16:9, 4:3, or letter box) with video signals. If you connect a TV compatible with the ID-1 system, the screen size is automatically selected.

ID-2 system

The ID-2 system sends a copyright protection signal with ID-1 signals inserted between video signals when you connect your camcorder to other equipment using an A/V connecting cable.

Using the fader function

You can fade in or out to give your recording a professional appearance.

[a] STBY REC

FADER



M.FADER*¹⁾
(mosaic)



BOUNCE*^{1) 2)}
(Fade in only)



OVERLAP
(Fade in only)



WIPE*³⁾
(Fade in only)



RANDOM DOT
(Fade in only)

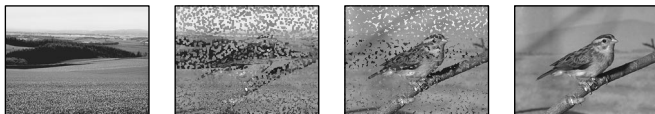

[b] STBY REC

MONOTONE

When fading in, the picture gradually changes from black-and-white to color.
When fading out the picture gradually changes from color to black-and-white.

*¹⁾ DCR-TRV6/TRV11 only

*²⁾ You can use this function only when
D ZOOM is set to OFF in the menu settings.

*³⁾ The sound does not wipe away.

Using the fader function

(1) When fading in [a]

In the standby mode, press FADER until the desired fader indicator flashes.

When fading out [b]

In the recording mode, press FADER until the desired fader indicator flashes.

The indicator changes as follows:

FADER → M.FADER* → BOUNCE* → MONOTONE → OVERLAP → WIPE → DOT → no indicator

The last selected fader mode is indicated first of all.

(2) Press START/STOP. The fader indicator stops flashing.

* DCR-TRV6/TRV11 only

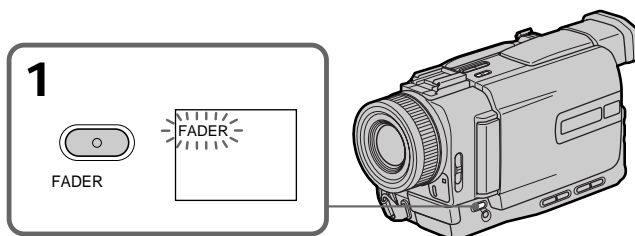

To cancel the fader function

After the fade in/out is carried out : Your camcorder automatically returns to the normal mode.

Before the fade in/out is carried out : Before pressing START/STOP, press FADER until the indicator disappears.

Note

You cannot use the following functions while using the fader function. Also, you cannot use the fader function while using the following functions:

- Digital effect
- Low lux mode of PROGRAM AE (Overlap, Wipe, or Random Dot function only)
- Super NightShot
- Tape Photo recording

When the OVERLAP, WIPE, or RANDOM DOT indicator appear in the standby mode

Your camcorder automatically stores the image recorded on a tape. As the image is being stored, the indicators flash fast, and the playback picture disappears. At this stage, the picture may not be recorded clearly, depending on the tape condition.

While using the bounce function, you cannot use the following functions (DCR-TRV6/TRV11 only):

- Exposure
- Focus
- Zoom
- Picture effect

Note on the bounce function (DCR-TRV6/TRV11 only)

The BOUNCE indicator does not appear in the following mode or functions:

- D ZOOM is activated in the menu settings
- 16:9 wide
- Picture effect
- PROGRAM AE

While in memory mode (DCR-TRV11/TRV20 only)

You cannot use the fader function.

Using special effects – Picture effect

You can digitally process images to obtain special effects like those in films or on TV.

NEG. ART [a] : The color and brightness of the picture is reversed.

SEPIA : The picture gets sepia.

B&W : The picture appears in monochrome (black-and-white).

SOLARIZE [b] : The light intensity is clearer, and the picture looks like an illustration.

SLIM [c] : The picture expands vertically.

STRETCH [d] : The picture expands horizontally.

PASTEL [e] : The contrast of the picture is emphasized, and the picture looks like an animated cartoon.

MOSAIC [f] : The picture gets mosaic-patterned.

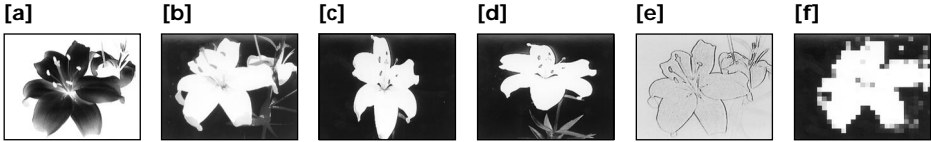

- (1) In the standby or recording mode, select P EFFECT in  in the menu settings. (p. 85).
- (2) Select the desired picture effect mode in the menu settings.

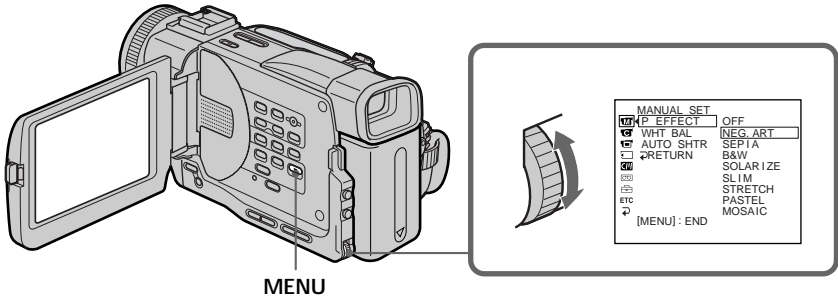

To cancel the picture effect function

Set P EFFECT to OFF in the menu settings.

While using the picture effect function

You cannot select the old movie mode with DIGITAL EFFECT.

When you turn the power off

Your camcorder automatically returns to the normal mode.

Using special effects – Digital effect

You can add special effects to recorded pictures using the various digital functions. The sound is recorded normally.

STILL

You can record a still picture so that it is superimposed on a moving picture.

FLASH (FLASH MOTION)

You can record still pictures successively at constant intervals.

LUMI. (LUMINANCEKEY)

You can swap a brighter area in a still picture with a moving picture.

TRAIL

You can record the picture so that an incidental image like a trail is left.

SLOW SHTR (SLOW SHUTTER)

You can slow down the shutter speed. The slow shutter mode is good for recording dark pictures more brightly. However, the picture may be less clear.

OLD MOVIE

You can add an old movie type atmosphere to pictures. Your camcorder automatically sets the wide mode to ON and picture effect to SEPIA, and the appropriate shutter speed.



Using special effects – Digital effect

- (1) In the standby or recording mode, press DIGITAL EFFECT. The digital effect indicator appears.
- (2) Turn the SEL/PUSH EXEC dial to select the desired digital effect mode. The indicator changes as follows:
STILL ↔ FLASH ↔ LUMI. ↔ TRAIL ↔ SLOW SHTR ↔ OLD MOVIE
- (3) Press the SEL/PUSH EXEC dial. The indicator lights up and the bars appear. In the STILL and LUMI. modes, the still picture is stored in memory.
- (4) Turn the SEL/PUSH EXEC dial to adjust the effect.

Items to be adjusted

STILL	The rate of the still picture you want to superimpose on the moving picture
FLASH	The interval of flash motion
LUMI.	The color scheme of the area in the still picture which is to be swapped with a moving picture
TRAIL	The time until the incidental image vanishes
SLOW SHTR	Shutter speed. The larger the shutter speed number, the slower the shutter speed.
OLD MOVIE	No adjustment necessary

The more bars there are on the screen, the stronger the digital effect. The bars appear in the following modes: STILL, FLASH, LUMI. and TRAIL.

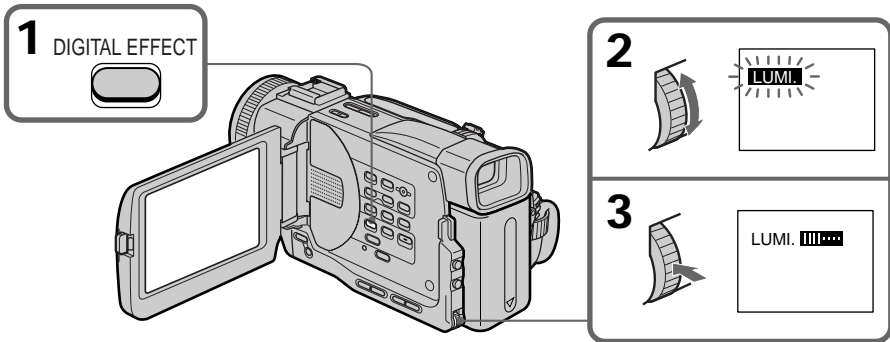

To cancel the digital effect function

Press DIGITAL EFFECT again.

Using special effects – Digital effect

Notes

- The following functions do not work during digital effect:
 - Fader
 - Low lux mode of PROGRAM AE
 - Tape photo recording
 - Super NightShot
- The following function does not work in the slow shutter mode:
 - PROGRAM AE
- The following functions do not work in the old movie mode:
 - Wide mode
 - Picture effect
 - PROGRAM AE

When you turn the power off

The digital effect will be automatically canceled.

When recording in the slow shutter mode

Auto focus may not be effective. Focus manually using a tripod.

Shutter speed

Shutter speed number	Shutter speed
SLOW SHTR 1	1/30
SLOW SHTR 2	1/15
SLOW SHTR 3	1/8
SLOW SHTR 4	1/4

Using the PROGRAM AE function

You can select PROGRAM AE (Auto Exposure) mode to suit your specific shooting requirements.

Spotlight mode

This mode prevents people's faces, for example, from appearing excessively white when shooting subjects lit by strong light in the theater.

Soft portrait mode

This mode brings out the subject while creating a soft background for subjects such as people or flowers.

Sports lesson mode

This mode minimizes shake on fast-moving subjects such as in tennis or golf.

Beach & ski mode

This mode prevents people's faces from appearing dark in strong light or reflected light, such as at a beach in midsummer or on a ski slope.

Sunset & moon mode

This mode allows you to maintain atmosphere when you are recording sunsets, general night views, fireworks displays and neon signs.

Landscape mode

This mode is for when you are recording distant subjects such as mountains and prevents your camcorder from focusing on glass or metal mesh in windows when you are recording a subject behind glass or a screen.

Low lux mode

This mode makes subjects brighter in insufficient light.



Using the PROGRAM AE function

- (1) In the standby or memory mode, press PROGRAM AE. The PROGRAM AE indicator appears.
- (2) Turn the SEL/PUSH EXEC dial to select the desired PROGRAM AE mode. The indicator changes as follows:

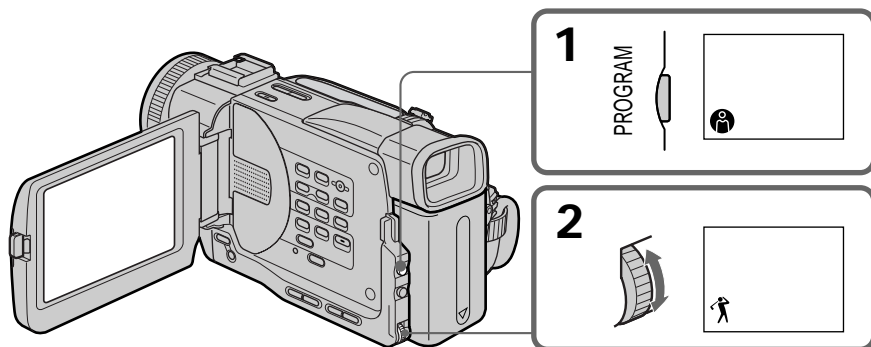

To cancel the PROGRAM AE function

Press PROGRAM AE again.

Notes

- In the spotlight, sports lesson and beach & ski modes, you cannot take close-ups. This is because your camcorder is set to focus only on subjects in the middle to far distance.
- In the sunset & moon and landscape modes, your camcorder is set to focus only on distant subjects.
- The following functions do not work in the PROGRAM AE mode:
 - Slow shutter
 - Old movie
 - Bounce (DCR-TRV6/TRV11 only)
- The following functions do not work in the low lux mode:
 - Digital effect
 - Overlap
 - Wipe
 - Random dot
- While setting the NIGHTSHOT to ON, the PROGRAM AE function does not work. (The indicator flashes.)
- While shooting in memory mode, the low lux and sports lesson modes do not work. (The indicator flashes.)

While WHT BAL is set to AUTO in the menu settings

The white balance is adjusted even if the PROGRAM AE function is selected.

Even if the PROGRAM AE function is selected

You can adjust the exposure.

If you are recording under a discharge tube such as a fluorescent lamp, sodium lamp or mercury lamp

Flickering or changes in color may occur in the following modes. If this happens, turn the PROGRAM AE function off.

- Soft portrait mode
- Sports lesson mode

Adjusting the exposure manually

You can manually adjust and set the exposure. Adjust the exposure manually in the following cases:

- The subject is backlit
- Bright subject and dark background
- To record dark pictures (e.g. night scenes) faithfully

- (1) In the standby, recording or memory mode, press EXPOSURE. The exposure indicator appears.
- (2) Turn the SEL/PUSH EXEC dial to adjust the brightness.

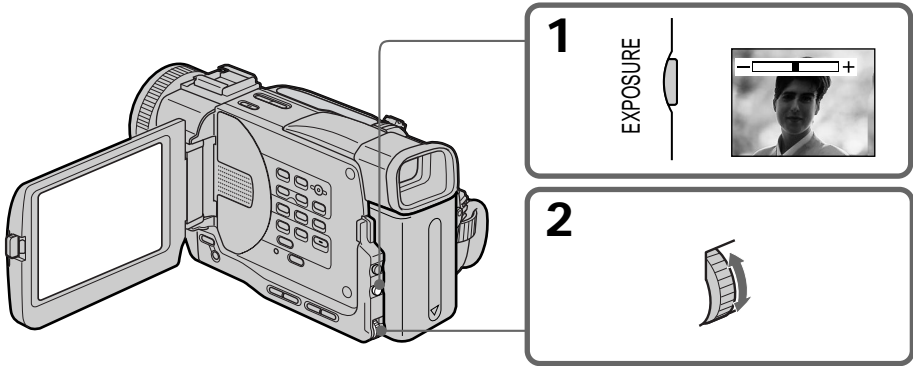

To return to the automatic exposure mode

Press EXPOSURE again.

Note

When you adjust the exposure manually, the backlight function does not work.

If you change the PROGRAM AE mode or slide NIGHTSHOT to ON

Your camcorder automatically returns to the automatic exposure mode.

Focusing manually

You can gain better results by manually adjusting the focus in the following cases:

- The autofocus mode is not effective when shooting
 - subjects through glass coated with water droplets
 - horizontal stripes
 - subjects with little contrast with backgrounds such as walls and sky
- When you want to change the focus from a subject in the foreground to a subject in the background
- Shooting a stationary subject when using a tripod

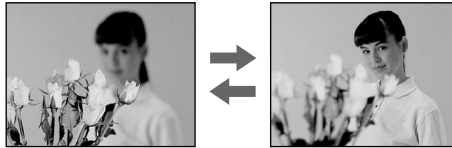

- (1) In the standby, recording or memory mode, set FOCUS to MAN. The  indicator appears.
- (2) Turn the focus ring to sharpen focus.

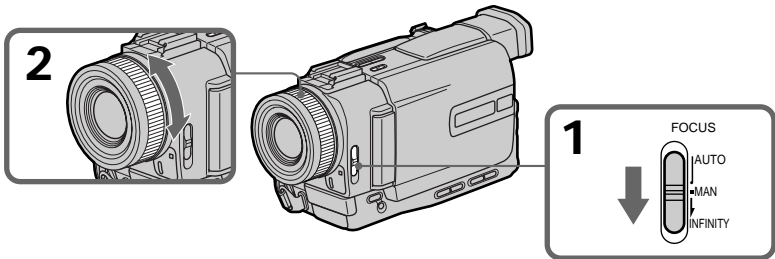

To return to the autofocus mode

Set FOCUS to AUTO.

To record distant subjects

When you press FOCUS down to INFINITY, the lens focuses on and  indicator appears. When you release FOCUS, your camcorder returns to the manual focus mode. Use this mode when your camcorder focuses on near objects even though you are trying to shoot a distant object.



To focus precisely

It is easier to focus on the subject if you adjust the zoom to shoot at the “W” (wide-angle) after focusing at the “T” (telephoto) position.

When you shoot close to the subject

Focus at the end of the “W” (wide-angle) position.

 changes as follows:

-  when recording a distant subject.
-  when the subject is too close to focus on.

Playing back a tape with picture effects

During playback, you can process a scene using the picture effect functions: NEG. ART, SEPIA, B&W and SOLARIZE.

In the playback or playback pause mode, select the desired picture effect mode in  in the menu settings (p. 85).

For details of each picture effect function, see page 37.

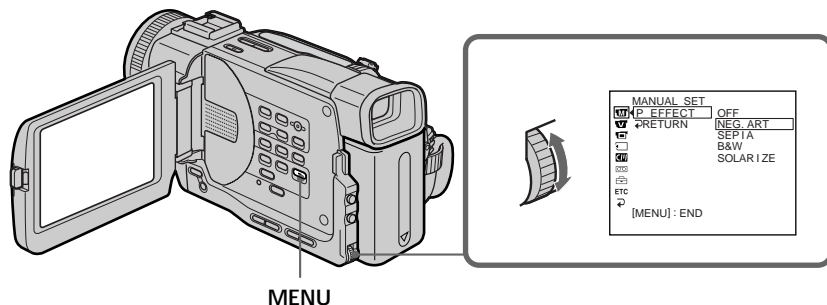

MENU

To cancel the picture effect function

Set P EFFECT to OFF in the menu settings.

Notes

- You cannot process the picture that is input from other equipment using the picture effect function.
- To record pictures that you have processed using the picture effect function, record the pictures on the VCR, using your camcorder as a player.

Pictures processed by the picture effect function

Pictures processed by the picture effect function are not output through the  DV IN/OUT jack.

When you set the POWER switch to OFF (CHG) or stop playing back

The picture effect function is automatically canceled.

Playing back a tape with digital effects

During playback, you can process a scene using the digital effect functions: STILL, FLASH, LUMI, and TRAIL.

- (1) In the playback/playback pause mode, press DIGITAL EFFECT and turn the SEL/PUSH EXEC dial until the desired digital effect indicator (STILL, FLASH, LUMI, or TRAIL) flashes.
- (2) Press the SEL/PUSH EXEC dial.
The digital effect indicator lights up and the bars appear. In the STILL or LUMI mode, the picture is captured and is stored in memory as a still picture at the time you press the SEL/PUSH EXEC dial.
- (3) Turn the SEL/PUSH EXEC dial to adjust the effect.
For details of each digital effect function, see page 38.

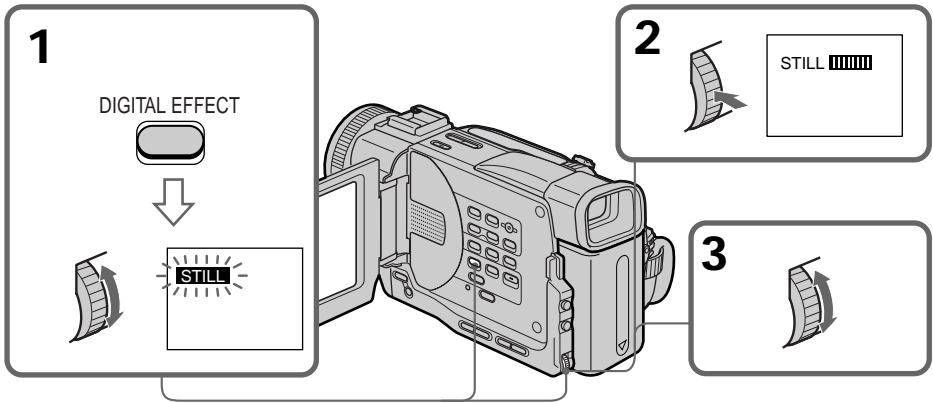

To cancel the digital effect function

Press DIGITAL EFFECT again.

Notes

- You cannot process externally input scenes using the digital effect function.
- To record pictures that you have processed using the digital effect, record the pictures on the VCR, using your camcorder as a player.

Pictures processed by the digital effect function

Pictures processed by the digital effect function are not output through the DV IN/OUT jack.

When you set the POWER switch to OFF (CHG) or stop playing back

The digital effect function is automatically canceled.

Enlarging images recorded on tapes – PB ZOOM

You can enlarge still and moving playback pictures. You can also dub the enlarged pictures to tapes or copy to “Memory Stick”s.

- (1) In the playback or playback pause mode, press PB ZOOM on your camcorder.
The image is enlarged, and $\uparrow \downarrow \leftarrow \rightarrow$ appears on the LCD screen or in the viewfinder.
- (2) Turn SEL/PUSH EXEC dial to move the enlarged image, then press the dial.
 \uparrow : The image moves downward
 \downarrow : The image moves upward
- (3) Turn SEL/PUSH EXEC dial to move the enlarged image, then press the dial.
 \rightarrow : The image moves leftward (Turn the dial to upward.)
 \leftarrow : The image moves rightward (Turn the dial to downward.)

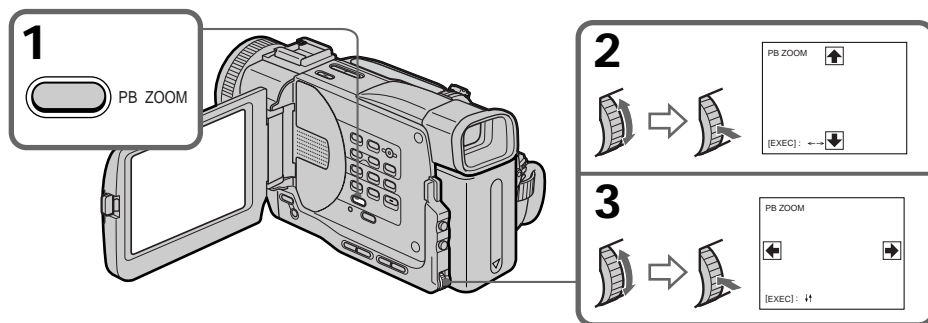

To cancel the PB ZOOM function

Press PB ZOOM again.

Note

You cannot process externally input scenes using the PB ZOOM function with your camcorder.

The following functions do not work in the PB ZOOM function:

- Digital effect

While displaying the menu settings or title

The PB ZOOM function does not work .

The PB ZOOM function is automatically canceled when you operate the following functions:

- Set the POWER switch to OFF (CHG)
- Stop playback
- Display the menu settings
- Display the title

Pictures in the PB ZOOM

Pictures in the PB ZOOM mode are not output through the \mathbb{I} DV IN/OUT jack.

Quickly locating a scene using the zero set memory function

Your camcorder goes forward or backward to automatically stop at a desired scene having a tape counter value of "0:00:00". You can do this with the Remote Commander.

- (1) In the playback mode, press DISPLAY.
- (2) Press ZERO SET MEMORY at the point you want to locate later. The tape counter shows "0:00:00" and the ZERO SET MEMORY indicator flashes.
- (3) Press ■ when you want to stop playback.
- (4) Press ◀◀ to rewind the tape to the tape counter's zero point. The tape stops automatically when the tape counter reaches approximately zero. The ZERO SET MEMORY indicator disappears and the time code appears.
- (5) Press ▶▶. Playback starts.

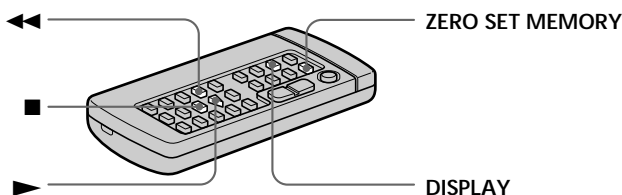

Notes

- When you press ZERO SET MEMORY before rewinding the tape, the zero set memory function will be canceled.
- There may be a discrepancy of several seconds from the time code.
- The zero set memory function may not work when there is a blank portion between pictures on a tape.



The zero set memory functions also in the recording standby mode

When you insert a scene in the middle of a recorded tape, press ZERO SET MEMORY at the point you want to end the insertion. Rewind the tape to the insert start point, and start recording. Recording stops automatically at the tape counter zero point. Your camcorder returns to the standby mode.

Searching the boundaries of recorded tape by title – Title search

CM
only

If you use a tape with cassette memory, you can search for the boundaries of recorded tape by title (Title search). Use the Remote Commander for this operation.

- (1) Set the POWER switch to VCR.
- (2) Set CM SEARCH in  to ON in the menu settings (p. 85). Factory setting is ON.
- (3) Press SEARCH MODE on the Remote Commander repeatedly, until the TITLE SEARCH indicator appears.
The indicator changes as follows:
TITLE SEARCH → DATE SEARCH → PHOTO SEARCH → PHOTO SCAN
→ no indicator
- (4) Press  or  on the Remote Commander to select the title for playback. Your camcorder automatically starts playback of the scene having the title that you selected.

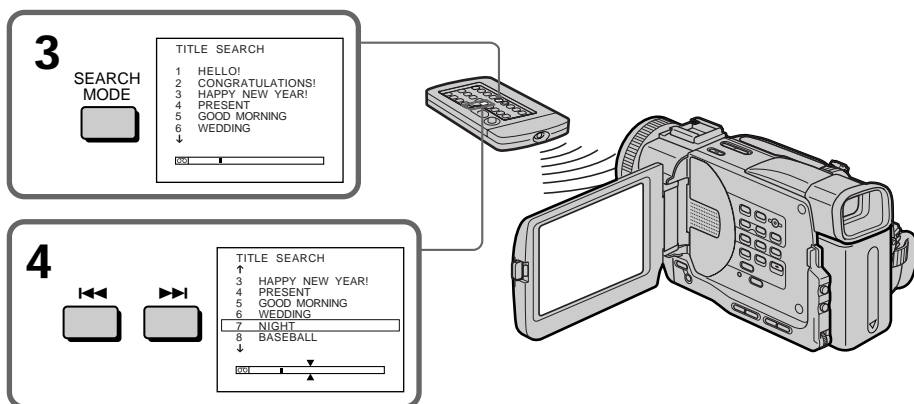





To stop searching

Press .

If you use a tape without cassette memory

You cannot superimpose or search a title.

In the  mark

- The bar in the  mark indicates the present point on the tape.
- The  mark in the  indicates the actual point you are trying to search.

If a tape has a blank portion between recorded portions

The title search function may not work correctly.

To superimpose a title

See page 77.



Searching a recording by date

- Date search

You can automatically search for the point where the recording date changes and start playback from that point (**Date search**). Use a tape with cassette memory for convenience. Use the Remote Commander for this operation. Use this function to check where recording dates change or to edit the tape at each recording date.

Searching for the date by using cassette memory

You can use this function only when playing back a tape with cassette memory (p. 124).

- (1) Set the POWER switch to VCR.
- (2) Set CM SEARCH in  to ON in the menu settings (p. 85). Factory setting is ON.
- (3) Press SEARCH MODE on the Remote Commander repeatedly, until the DATE SEARCH indicator appears.
The indicator changes as follows:
TITLE SEARCH → DATE SEARCH → PHOTO SEARCH → PHOTO SCAN → no indicator
- (4) Press  or  on the Remote Commander to select the date for playback. Your camcorder automatically starts playback at the beginning of the selected date.

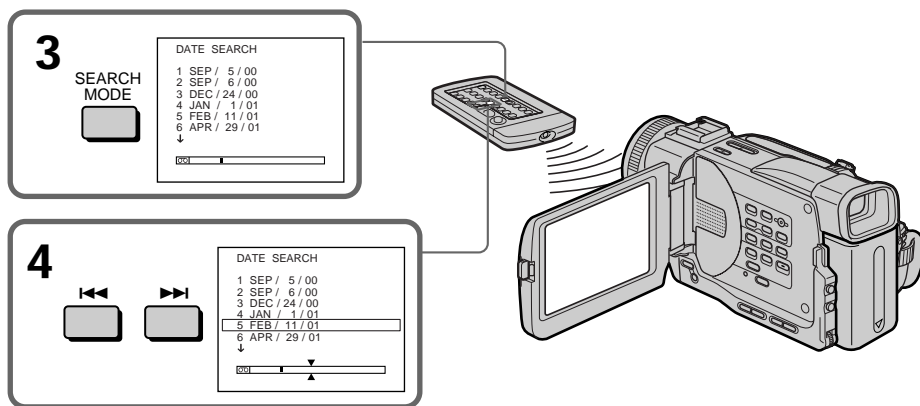





To stop searching
Press .

Searching a recording by date – Date search

Note

If one day's recording is less than two minutes, your camcorder may not accurately find the point where the recording date changes.

In the  mark

- The bar in the  mark indicates the present point on the tape.
- The  mark in the  indicates the actual point you are trying to search.





If a tape has a blank portion between recorded portions

The date search function may not work correctly.

Cassette memory

The tape cassette memory can hold six recording date data. If you search the date among seven or more data, see “Searching for the date without using cassette memory” below.

Searching for the date without using cassette memory

- (1) Set the POWER switch to VCR.
- (2) Set CM SEARCH in  to OFF in the menu settings (p. 85).
- (3) Press SEARCH MODE on the Remote Commander repeatedly, until the DATE SEARCH indicator appears.
The indicator changes as follows:
DATE SEARCH → PHOTO SEARCH → PHOTO SCAN → no indicator
- (4) Press  on the Remote Commander to search for the previous date or press  on the Remote Commander to search for the next date. Your camcorder automatically starts playback at the point where the date changes. Each time you press  or , your camcorder searches for the previous or next date.

To stop searching



Press .

Searching for a photo – Photo search/ Photo scan

You can search for a still picture you have recorded on a mini DV tape (**photo search**). You can also search for still pictures one after another and display each picture for five seconds automatically regardless of cassette memory (**photo scan**). Use the Remote Commander for these operations. Use this function to check or edit still pictures.

Searching for a photo by using cassette memory

You can use this function only when playing back a tape with cassette memory (p. 124).

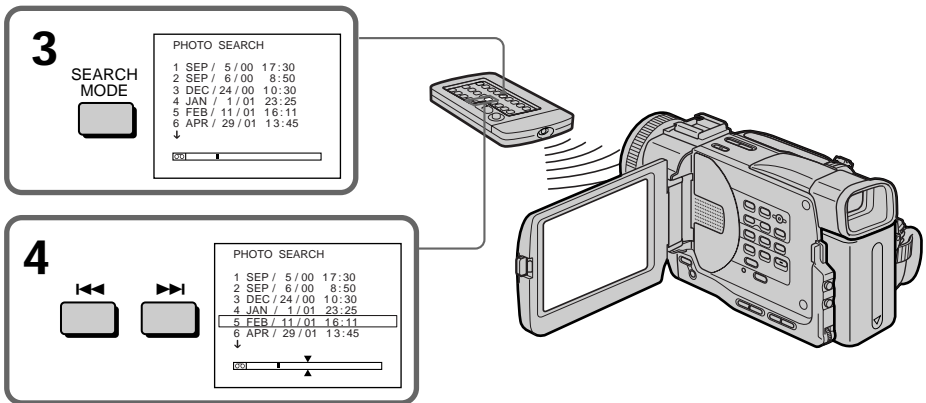

- (1) Set the POWER switch to VCR.
- (2) Set CM SEARCH in  to ON in the menu settings (p. 85). Factory setting is ON.
- (3) Press SEARCH MODE on the Remote Commander repeatedly, until the PHOTO SEARCH indicator appears.
The indicator changes as follows:
TITLE SEARCH → DATE SEARCH → PHOTO SEARCH → PHOTO SCAN → no indicator
- (4) Press  or  on the Remote Commander to select the date for playback. Your camcorder automatically starts playback of the photo having the date that you selected.



To stop searching

Press .

In the  mark

- The bar in the  mark indicates the present point on the tape.
- The  mark in the  indicates the actual point you are trying to search.





If a tape has a blank portion between recorded portions

The photo search function may not work correctly.

The available number of photos that can be searched using the cassette memory
The available number is up to 12 photos. However, you can search 13 photos or more using the scanning photo function.

Searching for a photo – Photo search/Photo scan



Searching for a photo without using cassette memory

- (1) Set the POWER switch to VCR.
- (2) Set CM SEARCH in  to OFF in the menu settings (p. 85).
- (3) Press SEARCH MODE on the Remote Commander repeatedly, until the PHOTO SEARCH indicator appears.
The indicator changes as follows:
DATE SEARCH → PHOTO SEARCH → PHOTO SCAN → no indicator
- (4) Press  or  on the Remote Commander to select the photo for playback.
Each time you press  or , your camcorder searches for the previous or next photo.
Your camcorder automatically starts playback of the photo.

To stop searching

Press .

Scanning photo

- (1) Set the POWER switch to VCR.
- (2) Press SEARCH MODE on the Remote Commander repeatedly, until the PHOTO SCAN indicator appears.
- (3) Press  or  on the Remote Commander.
Each photo is played back for about five seconds automatically.

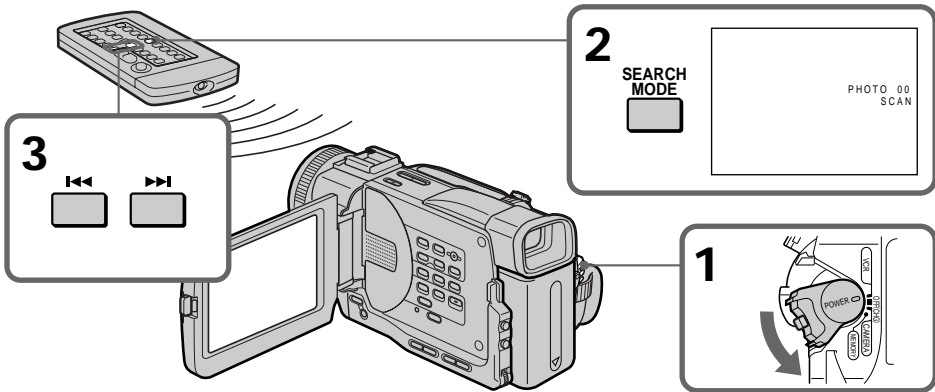

To stop scanning

Press .

Dubbing a tape

Using the A/V connecting cable

Connect your camcorder to the VCR using the A/V connecting cable supplied with your camcorder.

Set the input selector on the VCR to LINE, if available.

- (1) Insert a blank tape (or a tape you want to record over) into the VCR, and insert the recorded tape into your camcorder.
- (2) Prepare the VCR for recording, then set the input selector to LINE. Refer to the operating instructions of the VCR.
- (3) Set the POWER switch to VCR.
- (4) Play back the recorded tape on your camcorder.
- (5) Start recording on the VCR. Refer to the operating instructions of your VCR.

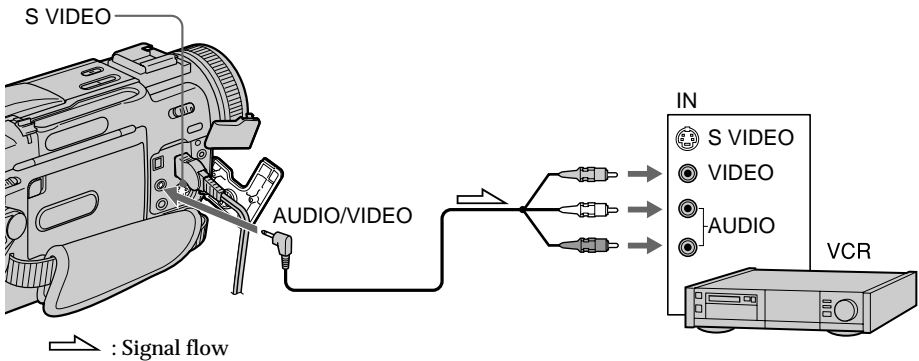

When you have finished dubbing a tape

Press **■** on both your camcorder and the VCR.

Before a dubbing

Set DISPLAY to LCD in the menu settings. (Default setting is LCD.)

Be sure to clear the indicators from the screen

If they are displayed, press the following buttons not to record the indicators on the dubbed tape:

- The DISPLAY button
- The DATA CODE button
- The SEARCH MODE button on the Remote Commander

You can edit on VCRs that support the following systems

8 8 mm, **Hi8** Hi8, **VHS** VHS, **S-VHS** S-VHS, **VHS-C** VHSC, **S-VHS-C** S-VHSC, **B** Betamax, **ED Beta** ED Betamax, **Mini DV** mini DV, **DV** DV, **D** Digital8

If your VCR is a monaural type

Connect the yellow plug of the A/V connecting cable to the video input jack and the white or the red plug to the audio input jack on the VCR or the TV. When the white plug is connected, the left channel audio is output, and the red plug is connected, the right channel audio is output.

Dubbing a tape

Connect using an S video cable (not supplied) to obtain high-quality pictures

With this connection, you do not need to connect the yellow (video) plug of the A/V connecting cable.

Connect an S video cable (not supplied) to the S video jacks of both your camcorder and the VCR.

This connection produces higher quality DV format pictures.

Using the i.LINK cable (DV connecting cable)

Simply connect the i.LINK cable (DV connecting cable) (not supplied) to **i** DV IN/OUT and to DV IN of the DV products. With digital-to-digital connection, video and audio signals are transmitted in digital form for high-quality editing. You cannot dub the titles, display indicators or the contents of cassette memory.

Set the input selector on the VCR to the DV input position if the VCR is equipped with the input selector.

- (1) Insert a blank tape (or a tape you want to record over) into the VCR, and insert the recorded tape into your camcorder.
- (2) Prepare the VCR for recording.
Set the input selector to LINE. Refer to the operating instructions of the VCR.
- (3) Set the POWER switch to VCR.
- (4) Play back the recorded tape on your camcorder.
- (5) Start recording on the VCR.

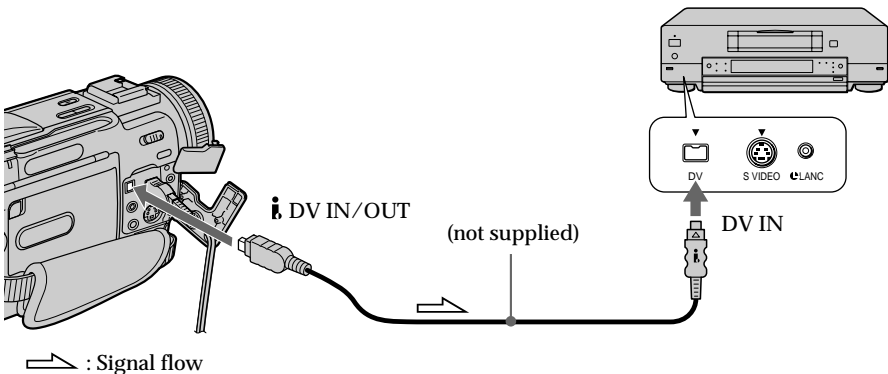

When you have finished dubbing a tape

Press **■** on both your camcorder and the connected DV product.

You can connect one VCR only using the i.LINK cable (DV connecting cable)

The following functions do not work during digital editing:

- Digital effect
- PB ZOOM
- Picture effect

If you record a playback pause picture with the **i** DV IN/OUT jack

The recorded picture becomes rough. And when you play back the picture using the other video equipment, the picture may jitter.

Dubbing only desired scenes – Digital program editing

You can duplicate selected scenes (programs) for editing onto a tape without operating the VCR.

Scenes can be selected by frame.

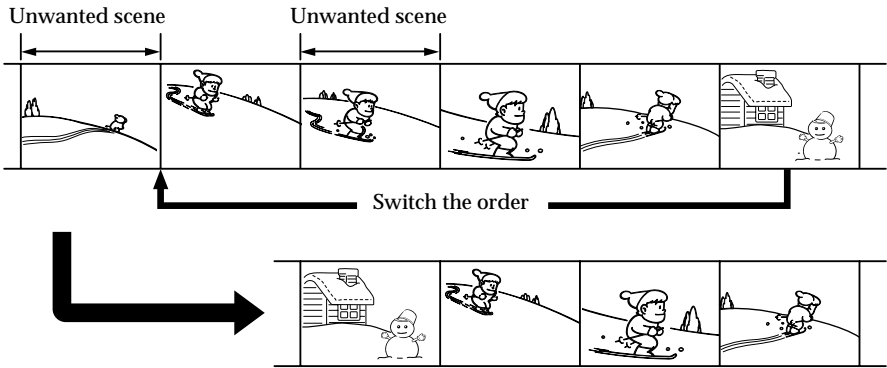

Before operating the digital program editing

Step 1 Connecting the VCR. (p. 54, 55)

Step 2 Setting the VCR for operation. (p. 57,60)

Step 3 Adjusting the synchronicity of the VCR. (p. 62)

When you dub using the same VCR again, you can skip steps 2 and 3.

Using the digital program editing function

Operation 1 Making the program. (p. 64)

Operation 2 Performing a digital program editing (dubbing a tape). (p. 65)

Step 1: Connecting the VCR

Connect your camcorder and the VCR as shown on pages 54, 55.

You can connect both an AV cable and an i.LINK cable (DV connecting cable).

Dubbing only desired scenes – Digital program editing

Step 2: Setting the VCR for operation - Using the infrared rays emitter

To edit using the VCR, send the control signal by infrared ray to the remote sensor on the VCR.

When you connect using an AV connecting cable, follow the procedures below.

Set the IR SETUP code

- (1) Set the POWER switch to VCR on your camcorder.
- (2) Turn the power of the connected VCR on, then set the input selector to LINE.
When you connect a video camera recorder, set its POWER switch to VCR/VTR.
- (3) Press MENU to display the menu.
- (4) Turn the SEL/PUSH EXEC dial to select **ETC**, then press the dial.
- (5) Turn the SEL/PUSH EXEC dial to select EDIT SET, then press the dial.
- (6) Turn the SEL/PUSH EXEC dial to select CONTROL, then press the dial.
- (7) Turn the SEL/PUSH EXEC dial to select IR, then press the dial.
- (8) Turn the SEL/PUSH EXEC dial to select IR SETUP, then press the dial.
- (9) Turn the SEL/PUSH EXEC dial to select the IR SETUP code of your VCR (P.58), then press the dial.

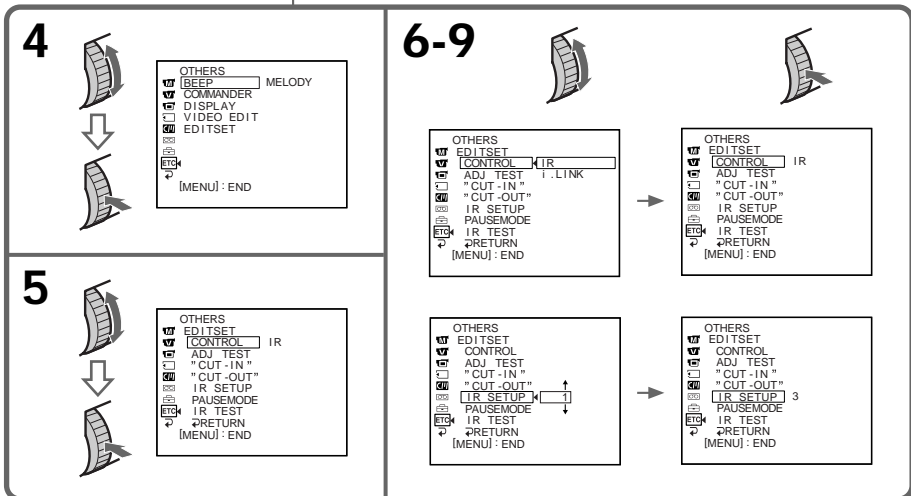
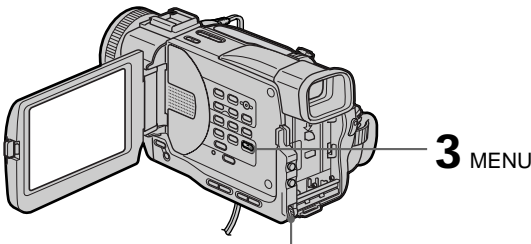

Dubbing only desired scenes - Digital program editing

About the IR SETUP code

The IR SETUP code is stored in the memory of your camcorder. Be sure to set the correct code, depending on your VCR. Code number 1 is preset at the factory.

Brand	Remote control mode
Sony	1, 2, 3, 4, 5, 6
Admiral (M. Wards)	89
Aiwa	80
Audio Dynamic	21, 35
Bell&Howell (M. Wards)	36
Brocsonic	70, 82
Canon	77, 78, 97
Citizen	47
Craig	73, 47
Curtis Mathis	08, 80, 77
Daewoo	26, 40, 77
DBX	21, 33, 35
Dimensia	08
Emerson	26, 82, 59, 48, 70, 81
Fisher	36, 45, 37, 44
Funai	80
General Electric	87, 08, 77, 32*, 94*
Goldstar	47
Hitachi	78, 08, 42
Instant Repley	77, 78
JC Penny	77, 42, 08, 36, 21, 33, 35
JVC	21, 12, 13, 14, 33, 35
Kenwood	21, 33, 47, 35
LXI (Sears)	80, 47, 42, 44, 45, 36, 37
Magnavox	83, 78, 77
Marantz	21, 33, 35
Marta	47
Memorex	77, 37
Minolta	42, 08
Mitsubishi/MGA	28, 22, 23, 24

Brand	Remote control mode
Multitech	23, 80, 32
NEC	21, 33, 35
Olympic	77, 78
Panasonic	16, 17, 78, 77, 96
Pentax	42, 08
Philco	78, 77
Philips	83, 78, 77
Pioneer	78
Quasar	78, 77, 16, 17
RCA/PROSCAN	08, 42, 16, 77, 83, 07, 40, 41, 78*
Realistic	77, 36
Sansui	21
Singer	73
Samsung	94, 41, 32, 32*, 94*, 24*
Sanyo	36, 37
Scott	40, 41, 32, 37, 28, 22, 23, 24
Sharp	89, 88
Shintom	73
Signature 2000 (M. Wards)	80, 89
Sylvania	83, 78, 77, 80
Symphonic	80
Tashiro	47
Tatung	21, 33, 35
Teac	21, 33, 80, 35
Technics	77, 78
Toshiba	40, 07
Wards	89, 88, 37, 95, 47
Yamaha	36, 21, 33, 35
Zenith	95

* TV/VCR component

Note on remote control mode

You cannot do the assemble editing with some VCRs (for recording) if the remote control mode does not correspond to this VCR (for playing).

Dubbing only desired scenes – Digital program editing

Setting the modes to cancel the recording pause on the VCR

- (1) Turn the SEL/PUSH EXEC dial to select PAUSEMODE, then press the dial.
- (2) Turn the SEL/PUSH EXEC dial to select the mode to cancel recording pause on the VCR, then press the dial.

The correct button depends on your VCR.

Refer to the operating instructions of your VCR.

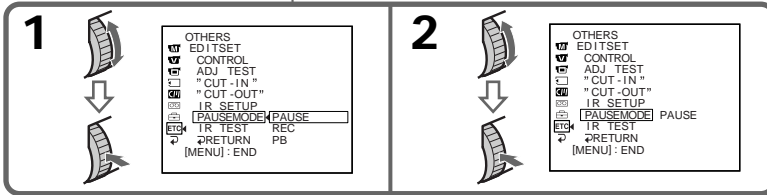
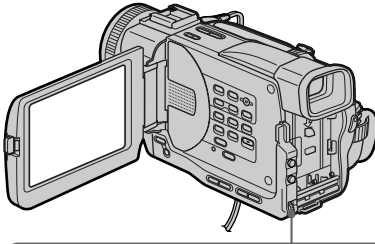

The buttons to cancel recording pause on the VCR

The buttons vary depending on your VCR. To cancel recording pause:

- Select playback pause if the button to cancel recording pause is **II**.
- Select recording if the button to cancel recording pause is **●**.
- Select playback if the button to cancel recording pause is **▶**.

Setting your camcorder and the VCR to face each other

Locate the infrared ray emitter of your camcorder and face it towards the remote sensor of the VCR.

Set the devices about 11 7/8 in. (30 cm) apart, and remove any obstacles between the devices.

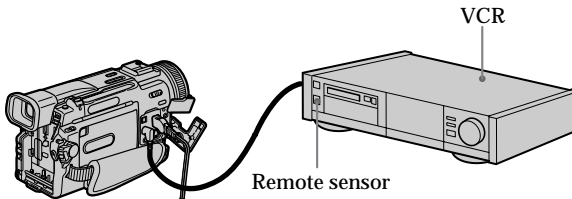

Dubbing only desired scenes - Digital program editing

Confirming the VCR operation

- (1) Insert a recordable tape into the VCR, then set to recording pause.
- (2) Turn the SEL/PUSH EXEC dial to select IR TEST, then press the dial.
- (3) Turn the SEL/PUSH EXEC dial to select EXECUTE, then press the dial.

If the VCR starts recording, the setting is correct.

The EXECUTING indicator flashes on the LCD screen or in the viewfinder.

When finished, the indicator changes to COMPLETE.

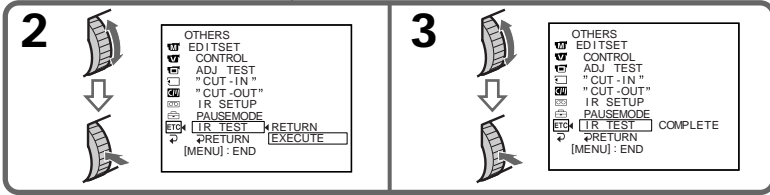
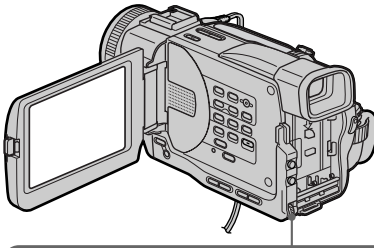

When the VCR does not operate correctly

- After checking the code in "About the IR SETUP code", set the "IR SETUP" or the "PAUSEMODE" again.
- Place your camcorder at least 11 7/8 in. (30 cm) away from the VCR.

Dubbing only desired scenes – Digital program editing

Step 2: Setting the VCR for operation - Using the i.LINK cable (DV connecting cable)

When you connect using i.LINK cable (DV connecting cable) (not supplied), follow the procedures below.

- (1) Set the POWER switch to VCR on your camcorder .
- (2) Turn the power of the connected VCR on, then set the input selector to DV input.

When you connect a digital video camera recorder, set its POWER switch to VCR/VTR.

- (3) Press MENU to display the menu.
- (4) Turn the SEL/PUSH EXEC dial to select **ETC**, then press the dial.
- (5) Turn the SEL/PUSH EXEC dial to select EDIT SET, then press the dial.
- (6) Turn the SEL/PUSH EXEC dial to select CONTROL, then press the dial.
- (7) Turn the SEL/PUSH EXEC dial to select i.LINK, then press the dial.

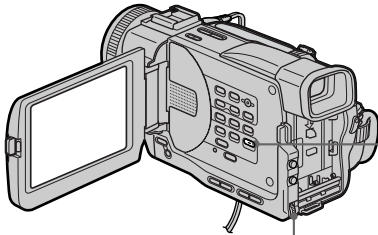

3 MENU

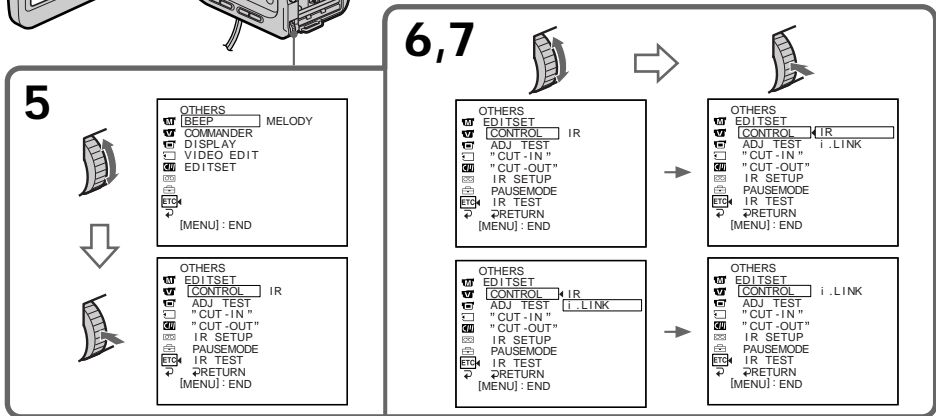

Step 3: Adjusting the synchronicity of the VCR

You can adjust the synchronicity of your camcorder and the VCR.
Have a pen and paper ready for notes.

- (1) Set the POWER switch to VCR on your camcorder.
- (2) Insert a blank tape (or a tape you want to record over) into the VCR, then set to recording pause.
When you select i.LINK in CONTROL, the above procedure is not necessary.
- (3) Turn the SEL/PUSH EXEC dial to select ADJ TEST, then press the dial.
- (4) Turn the SEL/PUSH EXEC dial to select EXECUTE, then press the dial.
IN and OUT are recorded on an image for five times each to calculate the numerical values for adjusting the synchronicity.
The EXECUTING indicator flashes on the LCD screen or in the viewfinder.
When finished, the indicator changes to COMPLETE.
- (5) Rewind the tape in the VCR, then start slow playback.
Take a note of the opening numerical value of each IN and the closing numerical value of each OUT.
- (6) Calculate the average of all the opening numerical values of each IN, and the average of all the closing numerical values of each OUT.
- (7) Turn the SEL/PUSH EXEC dial to select “CUT-IN”, then press the dial.
- (8) Turn the SEL/PUSH EXEC dial to select the average numerical value of IN, then press the dial.
The calculated start position for recording is set.
- (9) Turn the SEL/PUSH EXEC dial to select “CUT-OUT”, then press the dial.
- (10) Turn the SEL/PUSH EXEC dial to select the average numerical value of OUT, then press the dial.
The calculated stop position for recording is set.
- (11) Turn the SEL/PUSH EXEC dial to select RETURN, then press the dial.

Dubbing only desired scenes – Digital program editing

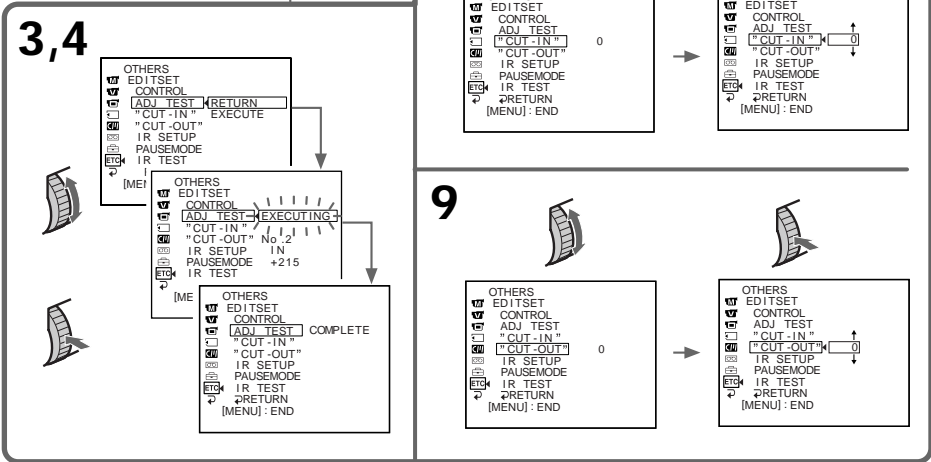
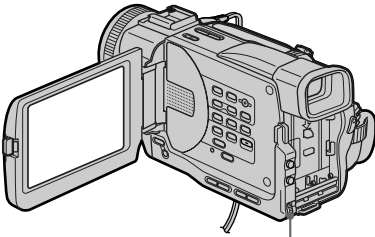

Notes

- If you start recording from the very beginning of the tape, the first few seconds of the tape may not record properly. Be sure to allow about 10 seconds' lead before starting the recording.
- You cannot dub the titles, display indicators, or the contents of cassette memory.
- When you connect with an i.LINK cable (DV connecting cable), you may not be able to operate the dubbing function correctly, depending on the VCR.
Set CONTROL to IR in the menu settings of your camcorder .
- When editing digital video, the operation signals cannot be sent with DIGITAL I/O/ (LANC).

If you connect using an i.LINK cable (DV connecting cable)

With digital-to-digital connection, video and audio signals are transmitted in digital form for high-quality editing.

When the operations of the VCR do not work with an i.LINK cable (DV connecting cable)

Keep the i.LINK connection, and select IR.

Dubbing only desired scenes - Digital program editing

Operation 1: Making the Program

- (1) Insert the tape for playback into your camcorder, and insert a tape for recording into the VCR.
- (2) Press MENU to display the menu.
- (3) Turn the SEL/PUSH EXEC dial to select **ETC**, then press the dial.
- (4) Turn the SEL/PUSH EXEC dial to select **VIDEO EDIT**, then press the dial.
- (5) Search for the beginning of the first scene you want to insert using the video operation buttons, then pause playback (p. 27).
- (6) Press **MARK** on the Remote Commander (DCR-TRV11/TRV20 only), or the SEL/PUSH EXEC dial.
The IN point of the first program is set, and the top part of the program mark changes to light blue.
- (7) Search for the end of the first scene you want to insert using the video operation buttons, then pause playback.
- (8) Press **MARK** on the Remote Commander (DCR-TRV11/TRV20 only), or the SEL/PUSH EXEC dial.
The OUT point of the first program is set, then the bottom part of the program mark changes to light blue.
- (9) Repeat steps 5 to 8, then set **PROGRAM**.
When the program is set, the program mark changes to light blue.
You can set maximum of 20 programs.

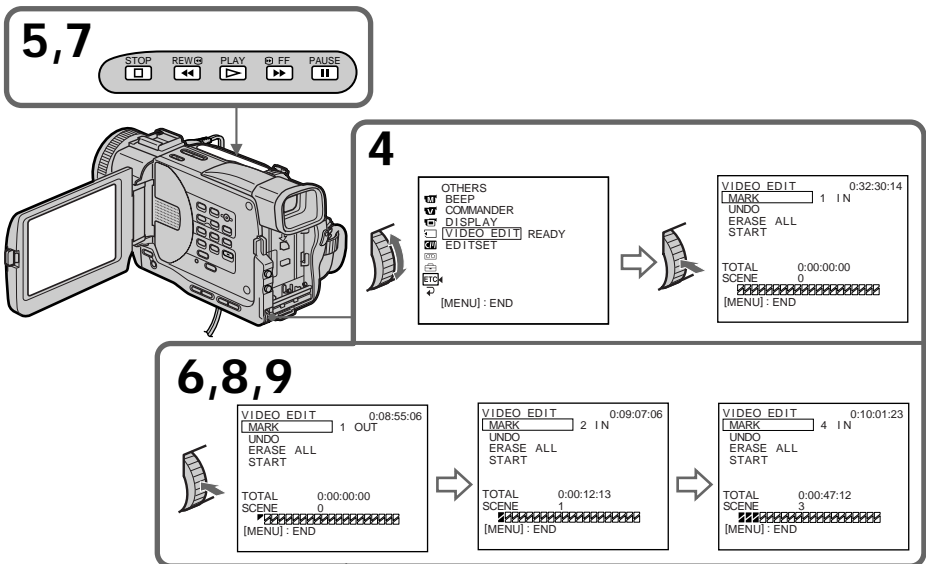

Erasing the program you have set

Erase OUT first and then IN from of the last program.

- (1) Turn the SEL/PUSH EXEC dial to select **UNDO**, then press the dial.
- (2) Turn the SEL/PUSH EXEC dial to select **EXECUTE**, then press the dial.
The last set program mark flashes, then the setting is cancelled.

To cancel erasing

Select **RETURN** in step 2, then press the dial.

Dubbing only desired scenes – Digital program editing

Erasing all programs

- (1) Select VIDEO EDIT in the menu settings. Turn the SEL/PUSH EXEC dial to select ERASE ALL, then press the dial.
- (2) Turn the SEL/PUSH EXEC dial to select EXECUTE, then press the dial.
All the program marks flash, then the settings are cancelled.

To cancel erasing all programs

Select RETURN in step 2, then press the dial.

To cancel a program you have set

Press MENU.

The program is stored in memory until the tape is ejected.

On a blank portion of the tape

You cannot set IN or OUT on a blank portion of the tape.

If there is a blank portion between IN and OUT on the tape

The total time code may not be displayed correctly.

Operation 2: Performing a digital program editing (Dubbing a tape)

Make sure your camcorder and VCR are connected, and that the VCR is set to recording pause. When you use an i.LINK cable (DV connecting cable) the following procedure is not necessary.

When you use a digital video camera recorder, set its POWER switch to VCR.

- (1) Select VIDEO EDIT. Turn the SEL/PUSH EXEC dial to select START, then press the dial.
- (2) Turn the SEL/PUSH EXEC dial to select EXECUTE, then press the dial.
Search for the beginning of the first program, then start dubbing.
The program mark flashes.
The SEARCH indicator appears during search, and the EDIT indicator appears during edit on the LCD screen or in the viewfinder.
The PROGRAM indicator changes to light blue after dubbing is complete.

When the dubbing ends, your camcorder and the VCR automatically stop.

To stop dubbing

Press ■ using the video operation buttons.

To end the program editing function

Your camcorder stops when the dubbing is complete. Then the display returns to VIDEO EDIT in the menu settings.

Press MENU to end the program editing function.

You cannot record on the VCR when:

- The cassette is not inserted.
- The tape has run out.
- The write-protect tab is set to expose the red mark.
- The IR SETUP code is not correct. (When IR is selected.)
- The button to cancel recording pause is not correct. (When IR is selected.) (see page 59)

NOT READY appears on the LCD screen when:



- The program to operate the digital program editing has not made.
- i.LINK is selected but an i.LINK cable (DV connecting cable) is not connected.
- The power of the connected VCR is not turned on. (when you set i.LINK).

Using with analog video unit and PC – Signal convert function

You can convert analog video signals into digital video signals via your camcorder connected to a PC and analog video unit.

Analog video signals → Digital video signals

You can capture images and sound from an analog video unit connecting a PC which has the i.LINK (DV) jack to your camcorder.

- (1) Set the POWER switch to VCR.
- (2) Set DISPLAY in  to LCD in the menu settings.
- (3) Set A/V → DV OUT in  to ON in the menu settings.
- (4) Start playback on the analog video unit slightly ahead of the point from which you want to start capturing images.
- (5) Start capturing procedures on your PC. The operation procedures depend on your PC and the software which you use.

For details on how to capture images, refer to the instruction manual of PC and software.

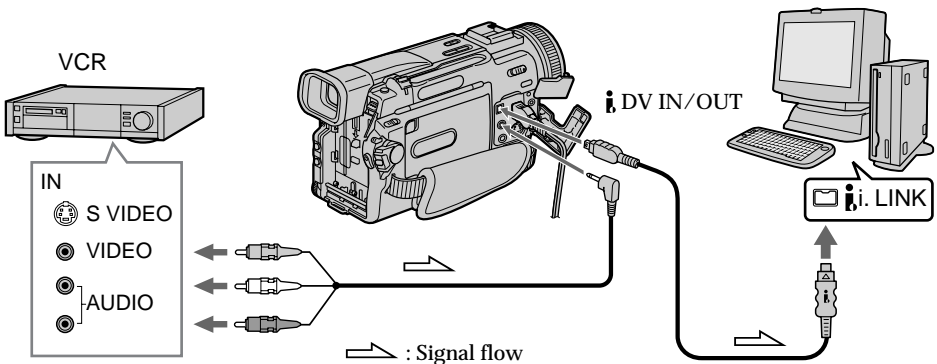

After capturing images and sound

Stop capturing procedures on your PC, and stop the playback on the analog video unit.

Notes

- You need to install software which can exchange video signals.
- Depending on the condition of the analog video signals, the PC may not be able to output the images correctly when you convert analog video signals into digital video signals via your camcorder. Depending on the analog video unit, the image may contain noise or incorrect colors.

Recording video or TV programs

Using the A/V connecting cable

You can record a tape from another VCR or a TV program from a TV that has video/audio outputs. Use your camcorder as a recorder.

- (1) Insert a blank tape (or a tape you want to record over) into your camcorder. If you are recording a tape from the VCR, insert a recorded tape into the VCR.
- (2) Set the POWER switch to VCR on your camcorder.
- (3) Set DISPLAY in  to LCD in the menu settings (p. 85).
- (4) Press ● REC and the button on its right simultaneously on your camcorder, then immediately press || on your camcorder.
- (5) Press ► on the VCR to start playback if you record a tape from a VCR. Select a TV program if you record from a TV. The picture from a TV or VCR appears on the LCD screen or in the viewfinder.
- (6) Press || on your camcorder at the scene where you want to start recording from.

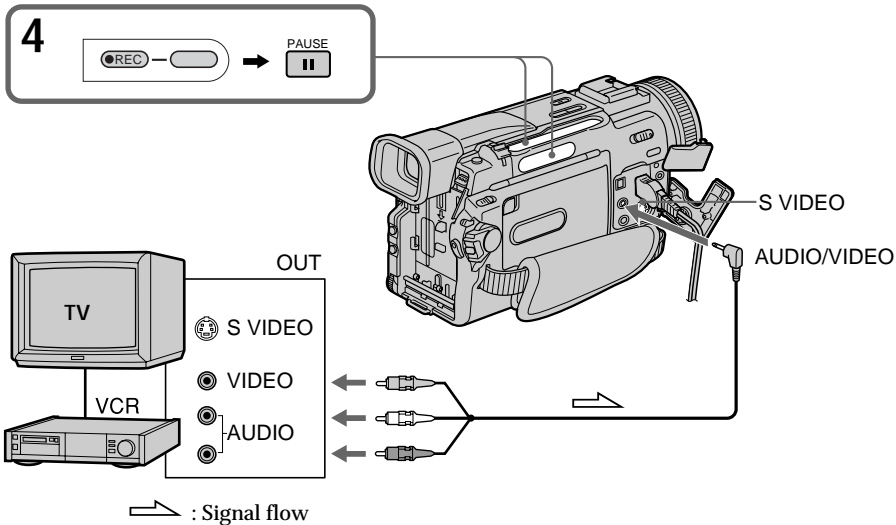

When you have finished dubbing a tape

Press ■ on both your camcorder and the VCR.

Using the Remote Commander (DCR-TRV11/TRV20 only)

In step 4, press ● REC and MARK simultaneously, then immediately press ||. And in step 6, press || at the scene where you want to start recording from.

Recording video or TV programs

Note

When the picture from the VCR or TV does not appear on the LCD screen or in the viewfinder, check if the A/V connecting cable is connected to the output jack for playback.

If your VCR is a monaural type

Connect the yellow plug of the A/V connecting cable to the video output jack and the white or the red plug to the audio output jack on the VCR or the TV. When the white plug is connected, the left channel audio is output, and the red plug is connected, the right channel audio is output.

Connect using an S video cable (not supplied) to obtain high-quality pictures

With this connection, you do not need to connect the yellow (video) plug of the A/V connecting cable.

Connect an S video cable (not supplied) to the S (S1) video jacks of both your camcorder and the VCR.

This connection produces higher quality DV format pictures.

Recording video or TV programs

Using the i.LINK cable (DV connecting cable)

Simply connect the i.LINK cable (DV connecting cable) (not supplied) to **i** DV IN/OUT and to DV IN/OUT of the DV products. With digital-to-digital connection, video and audio signals are transmitted in digital form for high-quality editing.

- (1) Insert a blank tape (or a tape you want to record over) into your camcorder, and insert the recorded tape into the VCR.
- (2) Set the POWER switch to VCR on your camcorder.
- (3) Set DISPLAY in **ETC** to LCD in the menu settings (p. 76).
- (4) Press **●** REC and the button on its right simultaneously on your camcorder, then immediately press **||** on your camcorder.
- (5) Press **▶** on the VCR to start playback. The picture to be recorded appears on the LCD screen or in the viewfinder.
- (6) Press **||** on your camcorder at the scene where you want to start recording from.

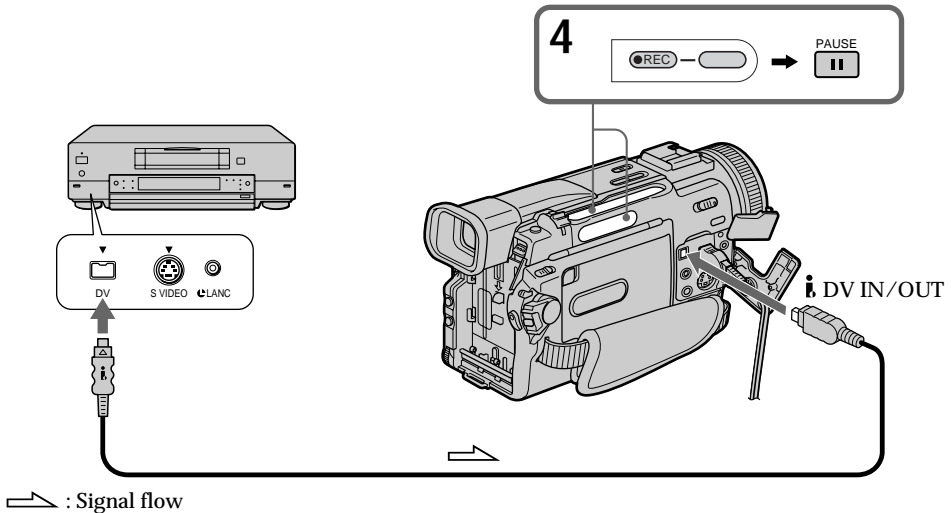

When you have finished dubbing a tape

Press **■** on both your camcorder and the VCR.

Using the Remote Commander (DCR-TRV11/TRV20 only)

In step 4, press **●** REC and MARK simultaneously, then immediately press **||**. And in step 6, press **||** at the scene where you want to start recording from.

Recording video or TV programs

You can connect one VCR only using the i.LINK cable (DV connecting cable)

When you dub a picture in digital form

The color of the display may be uneven. However this does not affect the dubbed picture.

If you record playback pause picture with the DV IN/OUT jack

The recorded picture becomes rough. And when you play back the picture using your camcorder, the picture may jitter.

Before recording

Make sure if the DV IN indicator appears on the LCD screen or in the viewfinder. The DV IN indicator may appear on both equipment.

Inserting a scene from a VCR – Insert editing

You can insert a new scene from a VCR onto your originally recorded tape by specifying the insert start and end points. Use the Remote Commander for this operation. Connections are the same as on page 67 or 69.

Insert a cassette containing the desired scene to insert into the VCR.

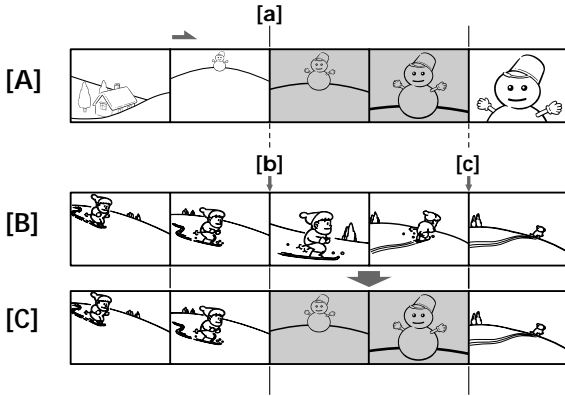

[A]: A tape that contains the scene to be superimposed

[B]: A tape before editing

[C]: A tape after editing

- (1) Set the POWER switch to VCR on your camcorder.
- (2) On the connected VCR, locate just before the insert start point [a], then press **II** to set the VCR to the playback pause mode.
- (3) On your camcorder, locate the insert end point [c] by pressing **◀◀** or **▶▶**. Then press **II** to set it to the playback pause mode.
- (4) Press ZERO SET MEMORY on the Remote Commander. The ZERO SET MEMORY indicator flashes and the end point of the insert is stored in memory. The tape counter shows "0:00:00."
- (5) On your camcorder, locate the insert start point [b] by pressing **◀◀**, then press **● REC** and the button on its right simultaneously.
- (6) First press **II** on the VCR, and after a few seconds press **II** on your camcorder to start inserting the new scene.

Inserting automatically stops near the zero point on the tape counter. Your camcorder automatically returns to the recording pause mode.

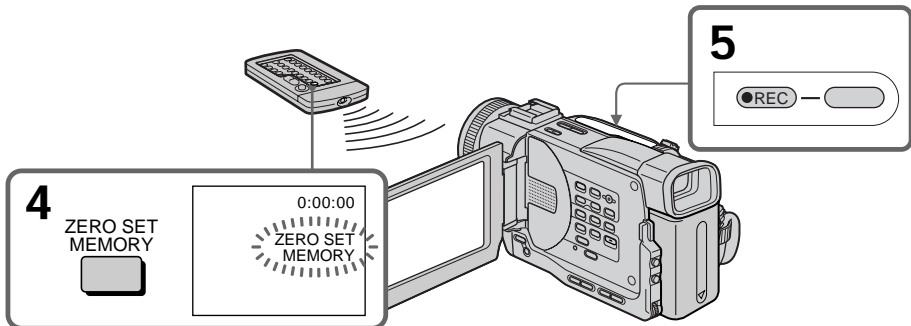

Inserting a scene from a VCR – Insert editing

To change the insert end point

Press ZERO SET MEMORY again after step 5 to erase the ZERO SET MEMORY indicator and begin from step 3.

Using the Remote Commander (DCR-TRV11/TRV20 only)

In step 5, press ●REC and MARK simultaneously, then immediately press ■. And in step 6, press ■ at the scene where you want to start recording from.

Note

The picture and sound recorded on the portion between the insert start and end points will be erased when you insert the new scene.

If you insert scenes on the tape recorded with other camcorder (including other DCR-TRV6/TRV11/TRV20)

The picture and sound may be distorted. We recommend that you insert scenes on a tape recorded with your camcorder.

When the inserted picture is played back

The picture and sound may be distorted at the end of the inserted portion. This is not a malfunction.

The picture and sound at the start point and the end point may be distorted in the LP mode.

To insert a scene without setting the insert end point

Skip steps 3 and 4. Press ■ when you want to stop inserting.

Audio dubbing

You can record an audio sound to add to the original sound on a tape by connecting audio equipment or a microphone. If you connect the audio equipment, you can add sound to your recorded tape by specifying starting and ending points. The original sound will not be erased.

Use the Remote Commander for this operation.

Connecting the microphone with the MIC jack

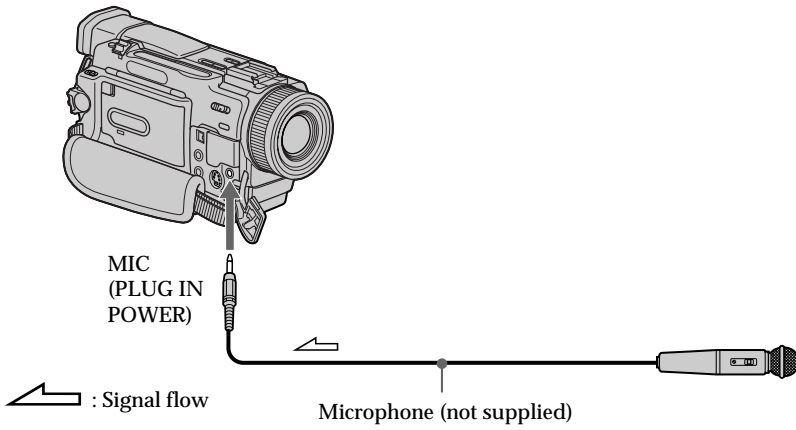

You can check the recorded picture and sound by connecting the AUDIO/VIDEO jack to a TV.

The recorded sound is not output from a speaker. Check the sound by using the TV or headphones.

Connecting the microphone with the intelligent accessory shoe

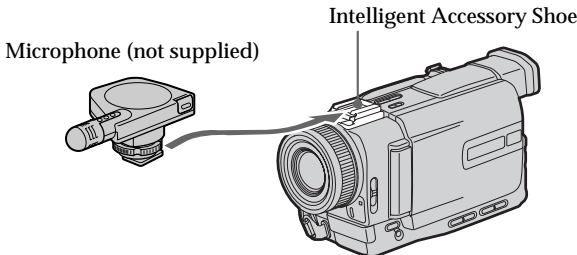

Audio dubbing

Dubbing with the AUDIO/VIDEO jack

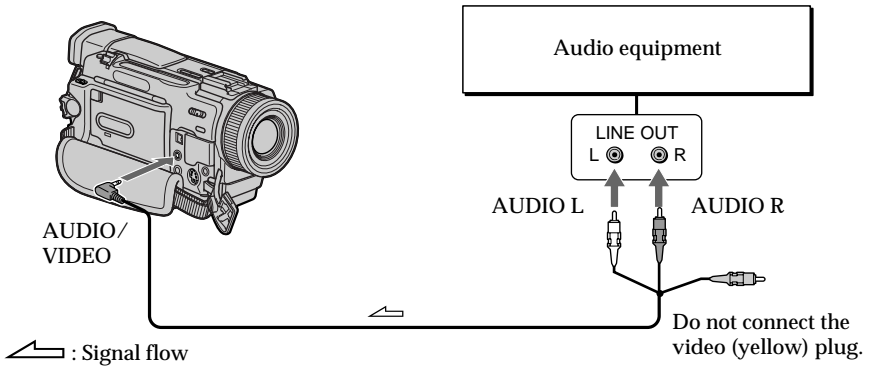

Dubbing with the built-in microphone

No connection is necessary.

Notes

- When dubbing with the AUDIO/VIDEO jack, you can check the recorded picture on the LCD screen or in the viewfinder, and can check the recorded sound by using a speaker or headphones.
- When dubbing with the built-in microphone or an external one, you can check the recorded picture on the LCD screen, in the viewfinder, or on the screen of equipment connected with the S VIDEO jack, and can check the recorded sound by using headphones.

Audio dubbing

Adding an audio sound on a recorded tape

- (1) Insert the recorded tape into your camcorder.
- (2) Set the POWER switch to VCR on your camcorder.
- (3) Locate the recording start point by pressing ► on the Remote Commander. Then press ■ at the point where you want to start recording to set your camcorder to the playback pause mode.
- (4) Press AUDIO DUB on the Remote Commander. The green ●■ indicator appears on the LCD screen or in the viewfinder.
- (5) Press ■ on the camcorder or on the Remote Commander and start playing back the audio you want to record at the same time. The new sound is recorded in stereo 2 (ST2) during playback.
- (6) Press ■ at the point where you want to stop recording.

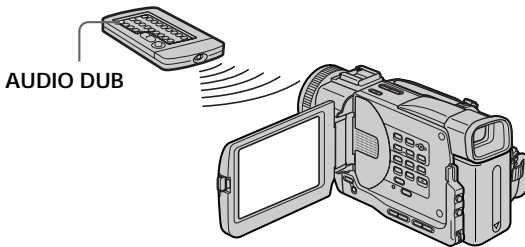

Monitoring the new recorded sound

To play back the sound

Adjust the balance between the original sound (ST1) and the new sound (ST2) by selecting AUDIO MIX in the menu settings (p. 85).

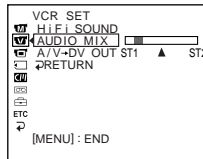

Five minutes after when you disconnect the power source or remove the battery pack, the setting of AUDIO MIX returns to the original sound (ST1) only. The default setting is original sound only.

Audio dubbing

Notes

- New sound cannot be recorded on a tape already recorded in the 16-bit mode (32 kHz, 44.1 kHz or 48 kHz) (p. 89).
- New sound cannot be recorded on a tape already recorded in the LP mode.
- You cannot add audio with the **i** DV IN/OUT jack.

If you make all the connections

The audio input to be recorded will take precedence over others in the following order.

- MIC (PLUG IN POWER) jack
- Intelligent accessory shoe
- AUDIO/VIDEO jack
- Built-in microphone

If an i.LINK cable (DV connecting cable) (not supplied) is connected to your camcorder

You cannot add a sound to a recorded tape.

To add new sound more precisely

Press ZERO SET MEMORY on the Remote Commander at the point where you want to stop recording later in the playback mode.

Carry out steps 3 to 5. Recording automatically stops at the point where ZERO SET MEMORY was pressed.

We recommend that you add new sound on a tape recorded with your camcorder

If you add new sound on a tape recorded with another camcorder (including DCR-TRV6/TRV11/TRV20), the sound quality may become worse.

If you set the write-protect tab of the tape to lock

You cannot record on a tape. Slide the write-protect tab to release the write protection.

On blank portions

You cannot add an audio.

Superimposing a title

CM
only

If you use a tape with cassette memory, you can superimpose the title while recording or after recording. When you play back the tape, the title is displayed for five seconds from the point where you superimposed it.

You can select one of eight preset titles and two custom titles (p. 81).



You can also select the color, size and position of titles.

- (1) In the standby, recording, playback or playback pause mode, press TITLE to display the title menu.
- (2) Turn the SEL/PUSH EXEC dial to select , then press the dial.
- (3) Turn the SEL/PUSH EXEC dial to select the desired title, then press the dial. The title is flashing.
- (4) Change the color, size, or position, if necessary.
 - ① Turn the SEL/PUSH EXEC dial to select the COLOR, SIZE or POSITION, then press the dial. The item appears.
 - ② Turn the SEL/PUSH EXEC dial to select the desired item, then press the dial.
 - ③ Repeat steps ① and ② until the title is laid out as desired.
- (5) Press the SEL/PUSH EXEC dial again to complete the setting.

In the recording, playback or playback pause mode:
The "TITLE SAVE" indicator appears on the screen for five seconds and the title is set.

In the standby mode:
The "TITLE" indicator appears. And when you press START/STOP to start recording, "TITLE SAVE" appears on the screen for five seconds and the title is set.

Superimposing a title

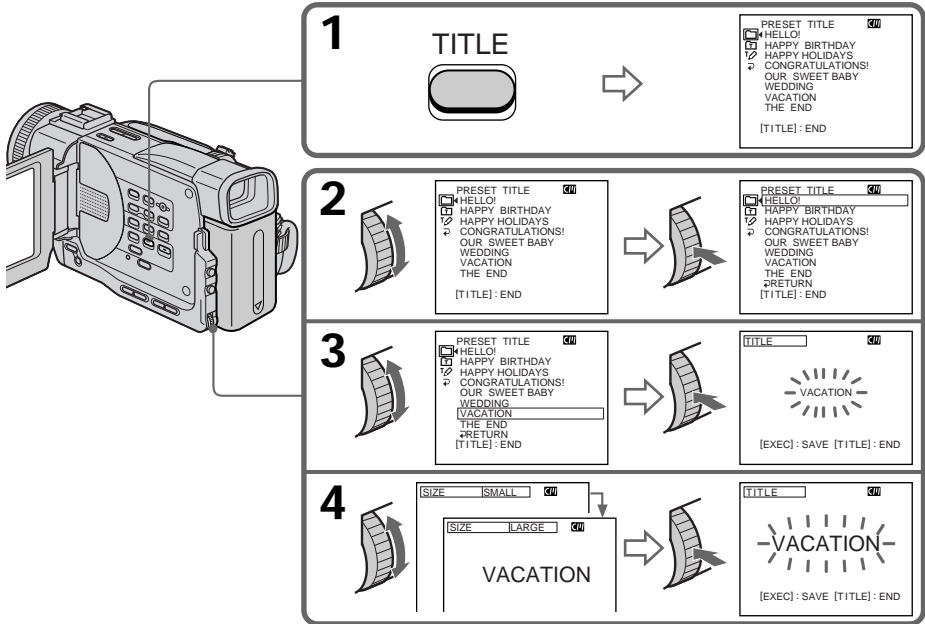

If you set the write-protect tab to lock

You cannot superimpose or erase the title. Slide the write-protect tab to release the write protection.

To use the custom title

If you want to use the custom title, select [T] in step 2.

If the tape has a blank portion

You cannot superimpose a title on the portion.

If the tape has a blank portion in the middle of the recorded parts

The title may not be displayed correctly.

The titles superimposed with your camcorder

- They are displayed by only the DV ^{Mini} DV format video equipment with index titler function.
- The point you superimposed the title may be detected as an index signal when searching a recording with other video equipment.

If the tape has too many index signals

You may not be able to superimpose a title because the memory is full. In this case, delete data you do not need.

Not to display titles

Set TITLE DSPL to OFF in the menu settings (p. 85).

Superimposing a title

Title setting

- The title color changes as follows:
WHITE ↔ YELLOW ↔ VIOLET ↔ RED ↔ CYAN ↔ GREEN ↔ BLUE
- The title size changes as follows:
SMALL ↔ LARGE
You cannot input more than 13 characters or more for a LARGE size.
- If you select the title size "SMALL," you have nine choices for the title position.
If you select the title size "LARGE," you have eight choices for the title position.

One cassette can have up to about 20 titles, if one title consists of five characters

However, if the cassette memory is full with date, photo and cassette label data, one cassette can have only up to about 11 titles with five characters each.

Cassette memory capacity is as follows:

- 6 date data (maximum)
- 12 photo data (maximum)
- 1 cassette label (maximum)

If the " FULL" mark appears

The cassette memory is full. If you erase the title in the cassette, you can label it.

Superimposing a title

Erasing a title

- (1) Set the POWER switch to VCR.
- (2) Press MENU to display the menu.
- (3) Turn the SEL/PUSH EXEC dial to select , then press the dial.
- (4) Turn the SEL/PUSH EXEC dial to select TITLEERASE, then press the dial.
Title erase display appears.
- (5) Turn the SEL/PUSH EXEC dial to select the title you want to erase, then press the dial.
“ERASE OK ?” indicator appears.
- (6) Make sure the title is the one you want to erase, and turn the SEL/PUSH EXEC dial to select ERASE, then press the dial.

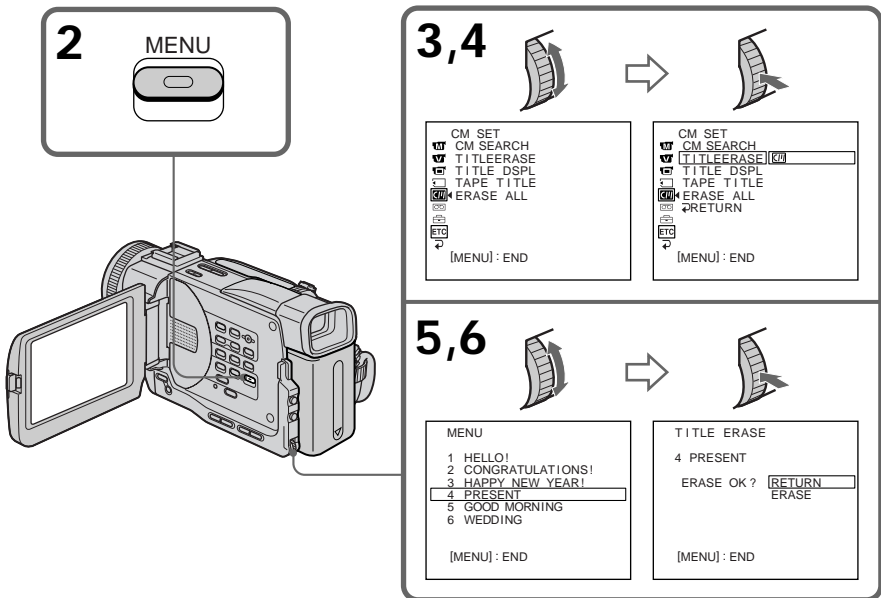

To cancel erasing a title

Select RETURN in step 6.

Making your own titles

CM only

You can make up to two titles and store them in cassette memory. Each title can have up to 20 characters.

- (1) Press TITLE in the standby or VCR mode.
- (2) Turn the SEL/PUSH EXEC dial to select , then press the dial.
- (3) Turn the SEL/PUSH EXEC dial to select the first line (CUSTOM1) or second line (CUSTOM2), then press the dial.
- (4) Turn the SEL/PUSH EXEC dial to select the column of the desired character, then press the dial.
- (5) Turn the SEL/PUSH EXEC dial to select the desired character, then press the dial.
- (6) Repeat steps 4 and 5 until you have selected all characters and completed the title.
- (7) To finish making your own titles, turn the SEL/PUSH EXEC dial to select [SET], then press the dial. The title is stored in memory.
- (8) Press TITLE to make the title menu disappear.









Editing

1

TITLE



PRESET TITLE

-  HELLO
-  HAPPY BIRTHDAY
-  HAPPY HOLIDAYS
-  CONGRATULATIONS!
-  OUR SWEET BABY
-  WEDDING
-  VACATION
-  THE END

[TITLE]: END

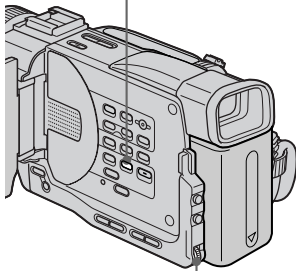

2

TITLE SET CM

CUSTOM1

CUSTOM2

[TITLE]: END

TITLE SET CM

CUSTOM1

CUSTOM2

[RETURN]

[TITLE]: END

3

TITLE SET CM

CUSTOM1

CUSTOM2

[RETURN]

[TITLE]: END

TITLE SET CM

ABCDE 12345

FGHIJ 67890

KL MNO . / -

QRST [<]

UVWXY [SET]

Z& ?!

[TITLE]: END

4

1

TITLE SET CM

ABCDE 12345

FGHIJ 67890

KL MNO . / -

QRST [<]

UVWXY [SET]

Z& ?!

[TITLE]: END

2

TITLE SET CM

ABCDE 12345

FGHIJ 67890

KL MNO . / -

QRST [<]

UVWXY [SET]

Z& ?!

[TITLE]: END

6

3

TITLE SET CM

ABCDE 12345

FGHIJ 67890

KL MNO . / -

QRST [<]

UVWXY [SET]

Z& ?!

[TITLE]: END

4

TITLE SET CM

S-----

ABCDE 12345

FGHIJ 67890

KL MNO . / -

QRST [<]

UVWXY [SET]

Z& ?!

[TITLE]: END

Making your own titles

To change a title you have stored

In step 3, select CUSTOM1 or CUSTOM2, depending on which title you want to change, then press the SEL/PUSH EXEC dial. Turn the SEL/PUSH EXEC dial to select [←], then press the dial to delete the title. The last character is erased. Enter the new title as desired.

If you take five minutes or longer to enter characters in the standby mode while a cassette is in your camcorder

The power automatically goes off. The characters you have entered remain stored in memory. Set the POWER switch to OFF (CHG) once and then to CAMERA again, then proceed from step 1.

We recommend setting the POWER switch to VCR or removing the cassette so that your camcorder does not automatically turn off while you are entering title characters.

To delete the title

Select [←]. The last character is erased.

To enter a space

Select [Z& ? !], then select the blank part.

Labeling a cassette

CM
only

If you use a tape with cassette memory, you can label a cassette. The label can consist of up to 10 characters and is stored in cassette memory. When you insert the labelled cassette and turn the power on, the label is displayed for about five seconds.

- (1) Insert the cassette you want to label.
- (2) Set the POWER switch to VCR.
- (3) Press MENU to display the menu.
- (4) Turn the SEL/PUSH EXEC dial to select , then press the dial.
- (5) Turn the SEL/PUSH EXEC dial to select TAPE TITLE, then press the dial. Tape title display appears.
- (6) Turn the SEL/PUSH EXEC dial to select the column of the desired character, then press the dial.
- (7) Turn the SEL/PUSH EXEC dial to select the desired character, then press the dial.
- (8) Repeat steps 6 and 7 until you finish the label.
- (9) Turn the SEL/PUSH EXEC dial to select [SET], then press the dial.
The label is stored in memory.

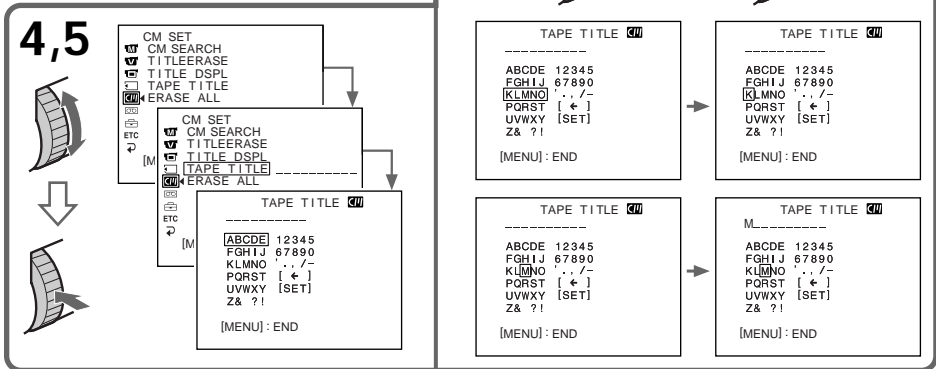
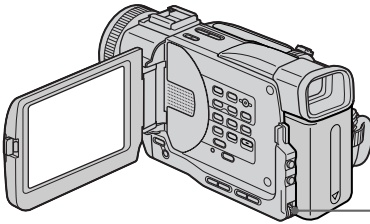

Labeling a cassette

To erase a character

In step 6 turn the SEL/PUSH EXEC dial to select [←], then press the dial. The last character is erased.

To change the label you have made

Insert the cassette to change the label, and operate in the same way to make a new label.

If you set the write-protect tab of the tape to lock

You cannot label the tape. Slide the write-protect tab to release the write protection.

If the mark appears in step 5

The cassette memory is full. If you erase the title in the cassette, you can label it.

If you have superimposed titles in the cassette

When the label is displayed, up to four titles also appear.

When the "-----" indicator has fewer than 10 spaces

The cassette memory is full.

The "-----" indicates the number of characters you can select for the label.

To enter a space

Select [Z& ? !], then select the blank part.

Changing the menu settings

To change the mode settings in the menu settings, select the menu items with the SEL/PUSH EXEC dial. The factory settings can be partially changed. First, select the icon, then the menu item and then the mode.

- (1) In the standby, memory or VCR mode, press MENU.
- (2) Turn the SEL/PUSH EXEC dial to select the desired icon, then press the dial to set.
- (3) Turn the SEL/PUSH EXEC dial to select the desired item, then press the dial to set.
- (4) Turn the SEL/PUSH EXEC dial to select the desired mode, then press the dial to set.
- (5) If you want to change other items, select ↶ RETURN and press the dial, then repeat steps 2 to 4.

For details, see “Selecting the mode setting of each item” (p. 86).

1

MENU

CAMERA

VCR

MANUAL SET
P EFFECT
WHT BAL
AUTO SHTR
ETC

[MENU] : END

MANUAL SET
P EFFECT
WHT BAL
AUTO SHTR
ETC

[MENU] : END

MEMORY

MANUAL SET
WHT BAL
ETC

[MENU] : END

2

MANUAL SET
P EFFECT
WHT BAL
OTHERS
ETC

OTHERS
WORLD TIME
BEEP
COMMANDER
DISPLAY
REC LAMP

OTHERS
WORLD TIME 0 HR
BEEP
COMMANDER
DISPLAY
REC LAMP
RETURN

3

OTHERS
WORLD TIME 0 HR
BEEP

OTHERS
WORLD TIME
BEEP
COMMANDER ON
DISPLAY
REC LAMP
RETURN

OTHERS
WORLD TIME
BEEP
COMMANDER ON
DISPLAY OFF
REC LAMP
RETURN

4

OTHERS
WORLD TIME
BEEP
COMMANDER ON
DISPLAY OFF
REC LAMP
RETURN









OTHERS
WORLD TIME
BEEP
COMMANDER OFF
DISPLAY
REC LAMP
RETURN

Changing the menu settings

To make the menu display disappear



Press MENU.

Menu items are displayed as the following icons:

-  MANUAL SET
-  CAMERA SET
-  VCR SET
-  LCD/VF SET
-  MEMORY SET (DCR-TRV11/TRV20 only)
-  CM SET
-  TAPE SET
-  SETUP MENU
-  OTHERS

Selecting the mode setting of each item ● is the default setting.

Menu items differ depending on the position of the POWER switch.

Icon/item	Mode	Meaning	POWER switch
 P EFFECT		To add special effects like those in films or on the TV to images (p. 37).	CAMERA VCR
WHT BAL		To adjust the white balance (p. 33).	CAMERA MEMORY
AUTO SHTR	● ON	To automatically activate the electronic shutter when shooting in bright conditions.	CAMERA
	OFF	To not automatically activate the electronic shutter even when shooting in bright conditions.	
 D ZOOM	● OFF	To deactivate the digital zoom. Up to 10× zoom is carried out.	CAMERA
	20×	To activate the digital zoom. More than 10× to 20× zoom is performed digitally (p. 20).	
	120×	To activate the digital zoom. More than 10× to 120× zoom is performed digitally (p. 20).	
16:9WIDE	● OFF	—	CAMERA
	ON	To record a 16:9 wide picture (p. 34).	
STEADYSHOT	● ON	To compensate for camera-shake.	CAMERA
	OFF	To cancel the SteadyShot function. Natural pictures are produced when shooting a stationary object with a tripod.	
N.S. LIGHT	● ON	To use the NightShot Light function (p. 22).	CAMERA MEMORY
	OFF	To cancel the NightShot Light function.	



Notes on the SteadyShot function

- The SteadyShot function will not correct excessive camera-shake.
- Attachment of a conversion lens (not supplied) may influence the SteadyShot function.

If you cancel the SteadyShot function

The SteadyShot off indicator  appears. Your camcorder prevents excessive compensation for camera-shake.

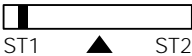
Changing the menu settings

Icon/item	Mode	Meaning	POWER switch
 HiFi SOUND	● STEREO	To play back a stereo tape or dual sound track tape with main and sub sound (p. 125).	VCR
	1	To play back a stereo tape with the left sound or a dual sound tape with main sound.	
	2	To play back a stereo tape with the right sound or a dual sound track tape with sub sound.	
AUDIO MIX		To adjust the balance between the stereo 1 and stereo 2 (p. 75).	VCR
			
A/V→DV OUT	● OFF	To output digital images and sound in analog format using your camcorder.	VCR
	ON	To output analog images and sound in digital format using your camcorder.	
 LCD B. L.	● BRT NORMAL	To set the brightness on the LCD screen normal.	VCR CAMERA MEMORY
	BRIGHT	To brighten the LCD screen.	
LCD COLOR		To adjust the color on the LCD screen, turn and press the SEL/PUSH EXEC dial.	VCR CAMERA MEMORY
			
VF B.L.	● BRT NORMAL	To set the brightness on the viewfinder screen to normal.	VCR CAMERA MEMORY
	BRIGHT	To brighten the viewfinder screen.	

Notes on LCD B.L.

- When you select “BRIGHT”, battery life is reduced by about 10 percent during recording.
- When you use power sources other than the battery pack, “BRIGHT” is automatically selected.

Notes on VF B.L.

When you select “BRIGHT”, battery life is reduced by about 10 percent during recording.

Changing the menu settings

Icon/item	Mode	Meaning	POWER switch
 *1) CONTINUOUS	● OFF	Not to record continuously.	MEMORY
	ON*2)	To record pictures continuously (p. 102).	
	MULTI SCRΝ	To record nine still pictures continuously (p. 102).	
QUALITY	● SUPER FINE*2)	To record still pictures in the super fine image quality mode, using the "Memory Stick" (p. 96).	VCR MEMORY
	FINE	To record still pictures in the fine image quality mode, using the "Memory Stick" (p. 96).	
	STANDARD	To record still pictures in the standard image quality mode, using the "Memory Stick" (p. 96).	
IMAGE SIZE*2)	● 1152×864	To record still pictures with 1152×864 size (p. 98).	MEMORY
	640×480	To record still pictures with 640×480 size (p. 98).	
PRINT MARK	ON	To write a print mark on the recorded still images you want to print out later.	VCR MEMORY
	● OFF	To erase print marks on still pictures.	
PROTECT	ON	To protect selected still pictures against accidental erasure (p. 120).	VCR MEMORY
	● OFF	Not to protect still pictures.	
SLIDE SHOW		To play back images in a continuous loop (p. 119).	MEMORY
DELETE ALL		To delete all the unprotected images (p. 122).	MEMORY
FORMAT	● RETURN	To cancel formatting.	MEMORY
	OK	To format an inserted "Memory Stick." 1. Select FORMAT with the SEL/PUSH EXEC dial, then press the dial. 2. Turn the SEL/PUSH EXEC dial to select OK, then press the dial. 3. After "EXECUTE" appears, press the SEL/PUSH EXEC dial. "FORMATTING" flashes during formatting. "COMPLETE" appears when formatting is finished.	
PHOTO SAVE		To duplicate mini DV still pictures on "Memory Stick" (p. 111).	VCR

*1) DCR-TRV11/TRV20 only

*2) DCR-TRV20 only

Note on IMAGE SIZE (DCR-TRV20 only):

When you set CONTINUOUS to MULTI SCRΝ or you set the POWER switch to VCR, IMAGE SIZE is automatically set to 640×480.

Notes on formatting



- Supplied "Memory Stick"s have been formatted at factory. Formatting with this camcorder is not required.
- Do not turn the POWER switch or press any button while the display shows "FORMATTING."
- You cannot format the "Memory Stick" if the write-protect tab on the "Memory Stick" is set to LOCK.
- Format again if the message "" appears.

Formatting erases all information on the "Memory Stick"

Check the contents of the "Memory Stick" before formatting.

- Formatting erases sample images on the "Memory Stick."
- Formatting erases the protected image data on the "Memory Stick."

Changing the menu settings

Icon/item	Mode	Meaning	POWER switch
 CM SEARCH	● ON	To search using cassette memory (p. 49).	VCR
	OFF	To search without using cassette memory.	
TITLEERASE		To erase the title you have superimposed (p. 80).	VCR CAMERA
TITLE DSPL	● ON	To display the title you have superimposed.	VCR
	OFF	Not to display the title.	
TAPE TITLE		To label a cassette (p. 83).	VCR CAMERA
ERASE ALL		To erase all the data in cassette memory.	VCR CAMERA
 REC MODE	● SP	To record in the SP (Standard Play) mode.	VCR CAMERA
	LP	To increase the recording time to 1.5 times the SP mode.	
AUDIO MODE	● 12BIT	To record in the 12-bit mode (two stereo sounds).	VCR CAMERA
	16BIT	To record in the 16-bit mode (the one stereo sound with high quality).	



Notes on the LP mode

- When you record a tape in the LP mode on your camcorder, we recommend playing the tape on your camcorder. When you play back the tape on other camcorders or VCRs, noise may occur in pictures or sound.
- When you record in the LP mode, we recommend using a Sony Excellence/Master mini DV cassette so that you can get the most out of your camcorder.
- You cannot make audio dubbing on a tape recorded in the LP mode. Use the SP mode for the tape to be audio dubbed.
- When you record in the SP and LP modes on one tape or you record some scenes in the LP mode, the playback picture may be distorted or the time code may not be written properly between scenes.

Notes on AUDIO MODE

- You cannot dub audio sound on a tape recorded in the 16-bit mode.
- When playing back a tape recorded in the 16-bit mode, you cannot adjust the balance in AUDIO MIX.

Changing the menu settings

Icon/item	Mode	Meaning	POWER switch
 REMAIN	● AUTO	To display the remaining tape bar: <ul style="list-style-type: none"> • for about 8 seconds after your camcorder is turned on and calculates the remaining amount of tape. • for about 8 seconds after a cassette is inserted and your camcorder calculates the remaining amount of tape. • for about 8 seconds after ► is pressed in VCR mode. • for about 8 seconds after DISPLAY is pressed to display the screen indicators. • for the period of tape rewinding, forwarding or picture search in the VCR mode. 	VCR CAMERA
	ON	To always display the remaining tape indicator.	
DATA CODE	● DATE/CAM	To display date, time and various settings during playback.	VCR
	DATE	To display date and time during playback.	
 CLOCK SET		To reset the date or time (p. 92).	CAMERA MEMORY
AUTO TV ON	● OFF	—	VCR CAMERA MEMORY
	ON	To automatically turn on a Sony TV when using the laser link function (P. 29).	
TV INPUT	● VIDEO1 VIDEO2 VIDEO3	To switch the video input on a Sony TV when using the laser function (P. 29).	VCR CAMERA MEMORY
	OFF	—	
LTR SIZE	● NORMAL	To display selected menu items in normal size.	VCR CAMERA MEMORY
	2×	To display selected menu items at twice the normal size.	
DEMO MODE	● ON	To make the demonstration appear.	CAMERA
	OFF	To cancel the demonstration mode.	

Notes on DEMO MODE

- You cannot select DEMO MODE when a cassette is inserted in your camcorder.
- DEMO MODE is set to STBY (Standby) at the factory and the demonstration starts about 10 minutes after you have set the POWER switch to CAMERA without a cassette inserted.
Note that you cannot select STBY of DEMO MODE in the menu settings.
- When NIGHTSHOT is set to ON, the NIGHTSHOT indicator appears on the LCD screen or in the viewfinder and you cannot select DEMO MODE in the menu settings.

Changing the menu settings

Icon/item	Mode	Meaning	POWER switch
 WORLD TIME		To set the clock to the local time. Turn the SEL/PUSH EXEC dial to set a time difference. The clock changes by the time difference you set here. If you set the time difference to 0, the clock returns to the originally set time.	CAMERA MEMORY
BEEP	● MELODY	To output the melody when you start/stop recording or when an unusual condition occurs on your camcorder.	VCR CAMERA MEMORY
	NORMAL	To output the beep instead of the melody.	
	OFF	To cancel the melody and beep sound.	
COMMANDER	● ON	To activate the Remote Commander supplied with your camcorder.	VCR CAMERA MEMORY
	OFF	To deactivate the Remote Commander to avoid remote control misoperation caused by other VCR's remote control.	
DISPLAY	● LCD	To show the display on the LCD screen and in the viewfinder.	VCR CAMERA MEMORY
	V-OUT/LCD	To show the display on the TV screen, LCD screen and in the viewfinder.	
REC LAMP	● ON	To light up the camera recording lamp at the front of your camcorder.	CAMERA MEMORY
	OFF	To turn the camera recording lamp off so that the person is not aware of the recording.	
VIDEO EDIT		To make program and perform video editing (p. 64).	VCR
EDIT SET		To adjust and set the synchronicity of your camcorder and a VCR for dubbing in edit set mode.	VCR

Note

If you press DISPLAY with DISPLAY set to V-OUT/LCD in the menu settings, the picture from a TV or VCR will not appear on the LCD screen even when your camcorder is connected to outputs on the TV or VCR.

When recording a close subject

When REC LAMP is set to ON, the red camera recording lamp on the front of the camcorder may reflect on the subject if it is close. In this case, we recommend you set REC LAMP to OFF.

In more than five minutes after removing the power source

The "AUDIO MIX", "COMMANDER", "HiFi SOUND", and "WHT BAL" items are returned to their factory settings.

The other menu items are held in memory even when the battery is removed.

Resetting the date and time

The clock is set at the factory to East Coast Standard time for the models sold in the United States, and to Japan, Hong Kong, New York or Panama time for other models. If you do not use your camcorder for about six months, the date and time settings may be released (bars may appear) because the vanadium-lithium battery installed in your camcorder will have been discharged (p. 139). First, set the year, then the month, the day, the hour and then the minute.

- (1) In the standby mode, press MENU to display the menu.
- (2) Turn the SEL/PUSH EXEC dial to select , then press the dial.
- (3) Turn the SEL/PUSH EXEC dial to select CLOCK SET, then press the dial.
- (4) Turn the SEL/PUSH EXEC dial to adjust the desired year, then press the dial.
- (5) Set the month, day and hour by turning the SEL/PUSH EXEC dial and pressing the dial.
- (6) Set the minute by turning the SEL/PUSH EXEC dial and pressing the dial by the time signal. The clock starts to move.
- (7) Press MENU to make the menu settings disappear.

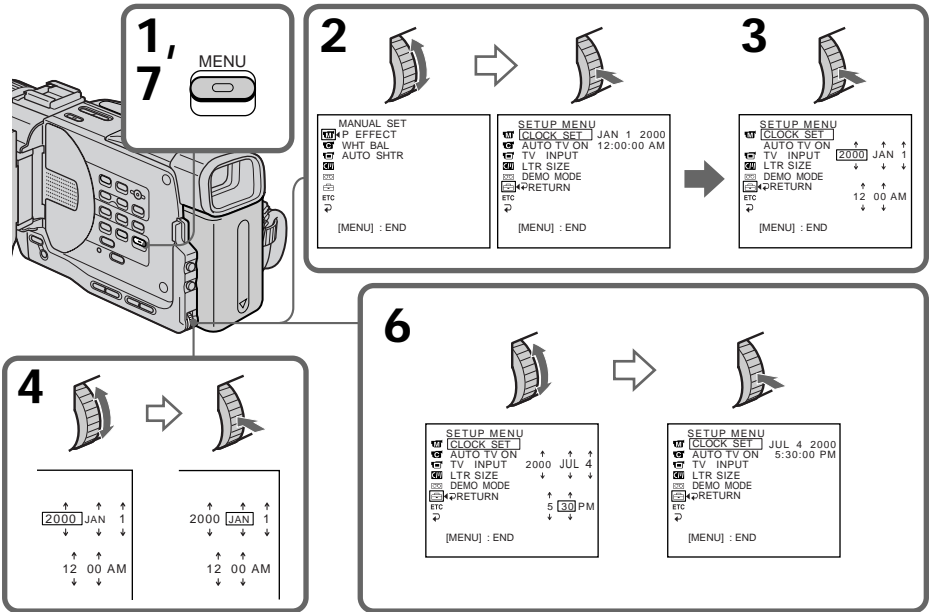

The year changes as follows:

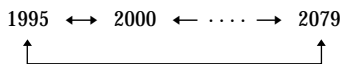

If you do not set the date and time

“--:--:--” is recorded on the data code of the tape and the “Memory Stick” (DCR-TRV11/TRV20 only).

Note on the time indicator

The internal clock of your camcorder operates on a 12-hour cycle.

- 12:00 AM stands for midnight.
- 12:00 PM stands for noon.

Using a “Memory Stick” – introduction

– DCR-TRV11/TRV20 only

You can record and play back still images on a “Memory Stick” supplied with your camcorder. You can easily play back, record or delete still images. You can exchange image data with other equipment such as a personal computer etc., using the PC serial cable for “Memory Stick” supplied with your camcorder or PC card adaptor for “Memory Stick” (not supplied).

On file format (JPEG)

Your camcorder compresses image data in JPEG format (extension .jpg).

Typical image data file name

100-0001: This file name appears on the LCD screen or in the viewfinder of your camcorder.

DSC00001.jpg: This file name appears on the display of your personal computer.

Using a “Memory Stick”

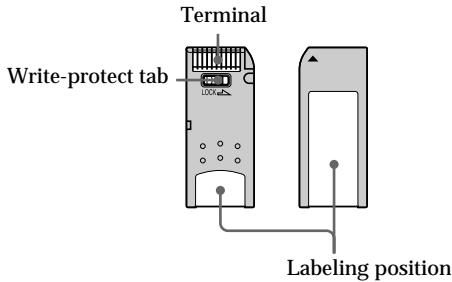

- You cannot record or erase still images when the write-protect tab on the “Memory Stick” is set to LOCK.
- We recommend backing up important data.
- Image data may be damaged in the following cases:
 - If you remove the “Memory Stick” or turn the power off while reading or writing.
 - If you use “Memory Stick”s near magnets or magnet fields.
- Prevent metallic objects or your finger from coming into contact with the metal parts of the connecting section.
- Stick its label on the labeling position.
- Do not bend, drop or apply strong shock to “Memory Stick”s.
- Do not disassemble or modify “Memory Stick”s.
- Do not let “Memory Stick”s get wet.
- Do not use or keep “Memory Stick”s in locations that are:
 - Extremely hot such as in a car parked in the sun or under the scorching sun.
 - Under direct sunlight.
 - Very humid or subject to corrosive gases.
- When you carry or store a “Memory Stick,” put it in its case.

Using a “Memory Stick” – introduction

Formatting the supplied “Memory Stick”

Formatting with this camcorder is not required. The “Memory Stick” has been formatted in the FAT-format at factory.

“Memory Stick” supplied with your camcorder

- Sample images are recorded in the “Memory Stick” (p. 107). Note that these images will be deleted if you format the “Memory Stick.”
- Stick the supplied label on the labeling position to prevent the accidental erasure. As for the labeling position, see the illustration on the previous page.

“Memory Stick”s formatted by a computer

“Memory Stick”s formatted by Windows OS or Macintosh computers do not have a guaranteed compatibility with this camcorder.

Notes on image data compatibility

- Image data files recorded on “Memory Stick”s by your camcorder conform with the Design Rules for Camera File Systems universal standard established by the JEIDA (Japan Electronic Industry Development Association). You cannot play back on your camcorder still images recorded on other equipment (DCR-TRV890E/TRV900/TRV900E or DSC-D700/D770) that does not conform with this universal standard. (These models are not sold in some areas.)
- If you cannot use the “Memory Stick” that is used with other equipment, format it with this camcorder (p. 88). However, formatting erases all information on the “Memory Stick.”

“Memory Stick” and  are trademarks of Sony Corporation.

- Windows is a registered trademark licensed to Microsoft Corporation, registered in the U.S.A. and other countries.
- All other product names mentioned herein may be the trademarks or registered trademarks of their respective companies.

Furthermore, “™” and “®” are not mentioned in each case in this manual.

Using a "Memory Stick" - introduction

Inserting a "Memory Stick"

- (1) Slide MEMORY OPEN in the direction of the arrow. The "Memory Stick" compartment opens.
- (2) Insert a "Memory Stick" in as far as it can go with its rounded corner facing up.
Then, close the "Memory Stick" compartment.

1

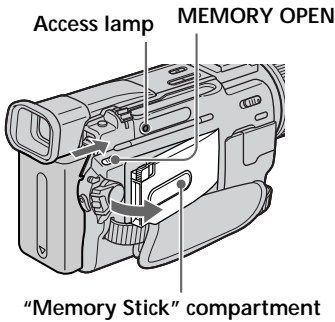

2

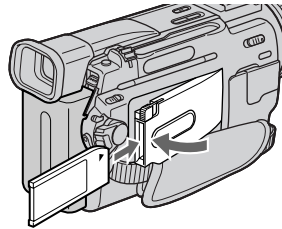

Ejecting a "Memory Stick"

Open the "Memory Stick" compartment in step 1, press MEMORY RELEASE. The "Memory Stick" comes out.

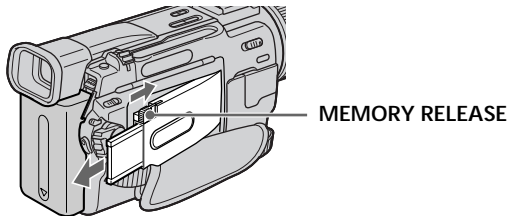

When the access lamp is lit or flashing

Never shake or strike your camcorder. Do not turn the power off, eject a "Memory Stick" or remove the battery pack. Otherwise, the image data breakdown may occur.

Using a "Memory Stick" - introduction

Selecting image quality mode

You can select image quality mode in still picture recording. Image quality is set to SUPER FINE mode at the factory.

- (1) Set the POWER switch to MEMORY or VCR. Make sure that the LOCK switch is set to the left (unlock) position.
- (2) Press MENU to display the menu.
- (3) Turn the SEL/PUSH EXEC dial to select , then press the dial.
- (4) Turn the SEL/PUSH EXEC dial to select QUALITY, then press the dial.
- (5) Turn the SEL/PUSH EXEC dial to select the desired image quality, then press the dial.

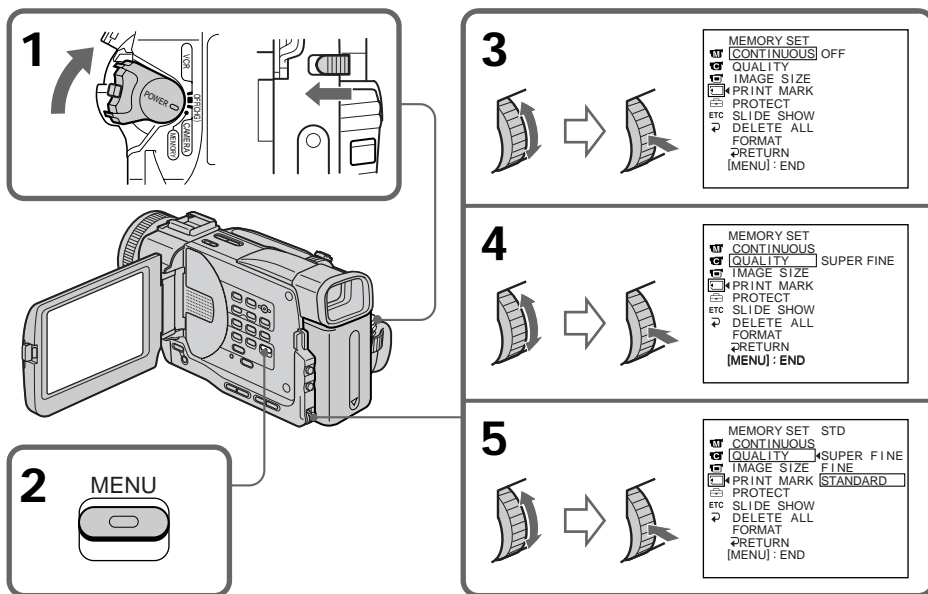

Note

In some cases, changing the image quality mode may not affect the image quality, depending on the types of images you are shooting.

Using a “Memory Stick” – introduction

Image quality settings

Setting	Meaning
SUPER FINE (SFN) (DCR-TRV20 only)	This is the highest image quality in your camcorder. The number of still images you can record is less than in FINE mode. The image is compressed to about 1/3. SFN appears on the screen.
FINE (FINE)	Use this mode when you want to record high quality images. The image is compressed to about 1/6. FINE appears on the screen.
STANDARD (STD)	This is the standard image quality. The image is compressed to about 1/10. STD appears on the screen.

Differences in image quality mode

Recorded images are compressed in JPEG format before being stored in memory. The memory capacity allotted to each image varies depending on the selected image quality mode and image size. Details are shown in the table below. (You can select 1152×864 or 640×480 image size in the menu settings.)

1152 × 864 image size (DCR-TRV20 only)

Image quality mode	Memory capacity
SUPER FINE	About 600 KB
FINE	About 300 KB
STANDARD	About 200 KB

640 × 480 image size

Image quality mode	Memory capacity
SUPER FINE (DCR-TRV20 only)	About 190 KB
FINE	About 100 KB
STANDARD	About 60 KB

Image quality mode indicator

The image quality mode indicator is not displayed during playback.

Using a "Memory Stick" - introduction

Selecting the image size

- DCR-TRV20 only

You can select either one of two image sizes: 1152×864 or 640×480. (In VCR mode, you can select only 640×480.)

- (1) Set the POWER switch to MEMORY. Make sure that the LOCK switch is set to the left (unlock) position.
- (2) Press MENU to display the menu.
- (3) Turn the SEL/PUSH EXEC dial to select , then press the dial.
- (4) Turn the SEL/PUSH EXEC dial to select IMAGE SIZE, then press the dial.
- (5) Turn the SEL/PUSH EXEC dial to select the desired image size, then press the dial.

The indicator changes as follows:

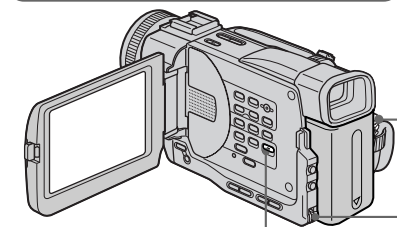
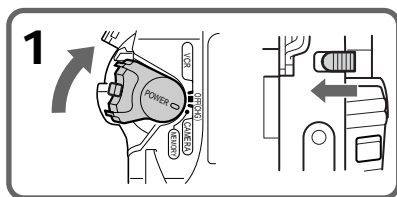

3



MEMORY SET
 [CONTINUOUS] OFF
 QUALITY
 [IMAGE SIZE] 
 PRINT MARK
 PROTECT
 ETC SLIDE SHOW
 DELETE ALL
 FORMAT
 RETURN
 [MENU]: END

4



MEMORY SET
 CONTINUOUS
 QUALITY
 [IMAGE SIZE] 1152×864
 PRINT MARK
 PROTECT
 ETC SLIDE SHOW
 DELETE ALL
 FORMAT
 RETURN
 [MENU]: END

5







MEMORY SET 
 CONTINUOUS
 QUALITY
 [IMAGE SIZE] 1152×864
 PRINT MARK [640×480]
 PROTECT
 ETC SLIDE SHOW
 DELETE ALL
 FORMAT
 RETURN
 [MENU]: END

Image size settings

Setting	Meaning	Indicator	
		Recording	Playback
1152 × 864	Records 1152 × 864 still images.		
640 × 480	Records 640 × 480 still images.		

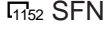
Note

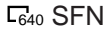
When images recorded on a camcorder in 1152×864 size are played back on a unit that does not support that size, the full image may not appear.

Using a “Memory Stick” – introduction

Approximate number of images you can record on a “Memory Stick”

The number of images you can record varies depending on which image quality mode and image size you select and the complexity of the subject.

1152×864 image size and SUPER FINE are selected with DCR-TRV20 only.

4MB type (supplied):

Image size	640 × 480	1152 × 864
SUPER FINE (SFN)	20 images	6 images
FINE (FINE)	40 images	12 images
STANDARD (STD)	60 images	18 images

8MB type (not supplied):

Image size	640 × 480	1152 × 864
SUPER FINE (SFN)	40 images	12 images
FINE (FINE)	81 images	25 images
STANDARD (STD)	122 images	37 images

16MB type (not supplied):

Image size	640 × 480	1152 × 864
SUPER FINE (SFN)	82 images	25 images
FINE (FINE)	164 images	51 images
STANDARD (STD)	246 images	75 images

32MB type (not supplied):

Image size	640 × 480	1152 × 864
SUPER FINE (SFN)	164 images	52 images
FINE (FINE)	329 images	104 images
STANDARD (STD)	494 images	152 images

64MB type (not supplied):

Image size	640 × 480	1152 × 864
SUPER FINE (SFN)	329 images	104 images
FINE (FINE)	659 images	208 images
STANDARD (STD)	988 images	304 images

Recording still images on “Memory Stick”s – Memory photo recording

- DCR-TRV11/TRV20 only

You can record still pictures on “Memory Stick”s.

Before operation

Insert a “Memory Stick” into your camcorder.

- (1) Set the POWER switch to MEMORY. Make sure that the LOCK switch is set to the left (unlock) position.
- (2) Keep pressing PHOTO lightly until the desired still picture appears. The green ● mark stops flashing, then lights up. The brightness of the picture and focus are adjusted, being targeted for the middle of the picture and are fixed. Recording does not start yet.
- (3) Press PHOTO deeper. The image displayed on the screen will be recorded on a “Memory Stick.” Recording is complete when the bar scroll indicator disappears.

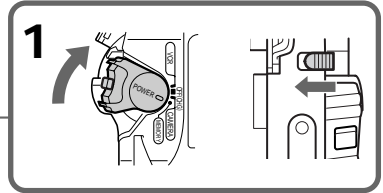
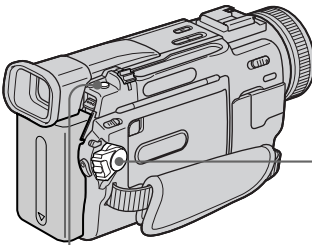

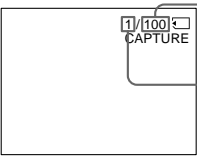
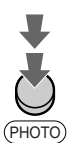
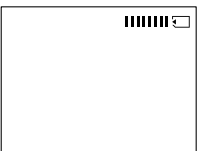
2 		Number of images can be recorded on the “Memory Stick” Number of recorded images
3 		

Recording still images on “Memory Stick”s – Memory photo recording

When the POWER switch is set to MEMORY

The following functions do not work:

- Wide TV mode
- Digital zoom
- SteadyShot function
- SUPER NIGHTSHOT
- Fader
- Picture effect
- Digital effect
- Title
- Low lux mode (The indicator flashes.)
- Sports lesson mode (The indicator flashes.)

While you are recording a still image

You can neither turn off the power nor press PHOTO.

When you press PHOTO on the Remote Commander

Your camcorder immediately records the image that is on the screen when you press the button.

Note

When recording still images at step 2 with the PHOTO button pressed lightly, the image momentarily flickers. This is not a malfunction.

When recording in memory mode

The angle of view is a little increased than one in CAMERA mode.

Recording still images on “Memory Stick”s – Memory photo recording

Recording images continuously

You can record still pictures continuously. Select one of the two modes described below before recording.

Continuous mode [a] (DCR-TRV20 only)

When the image size is set to 1152×864 , you can record up to four pictures continuously.

When the image size is set to 640×480 , you can record up to 16 pictures continuously. The number of recorded photos in continuous mode depends on the capacity of the “Memory Stick.”

Multi screen mode (Recording image size is 640×480) [b]

You can record nine still pictures continuously on a single page.

[a]



[b]



While pressing down PHOTO, your camcorder continuously record maximum number of still pictures depending on the image size.

When you stop pressing, the recording stops.

- (1) Set the POWER switch to MEMORY. Make sure that the LOCK switch is set to the left (unlock) position.
- (2) Press MENU to display the menu.
- (3) Turn the SEL/PUSH EXEC dial to select , then press the dial.
- (4) Turn the SEL/PUSH EXEC dial to select CONTINUOUS, then press the dial.
- (5) Turn the SEL/PUSH EXEC dial to select the desired setting, then press the dial.

Recording still images on “Memory Stick”s – Memory photo recording

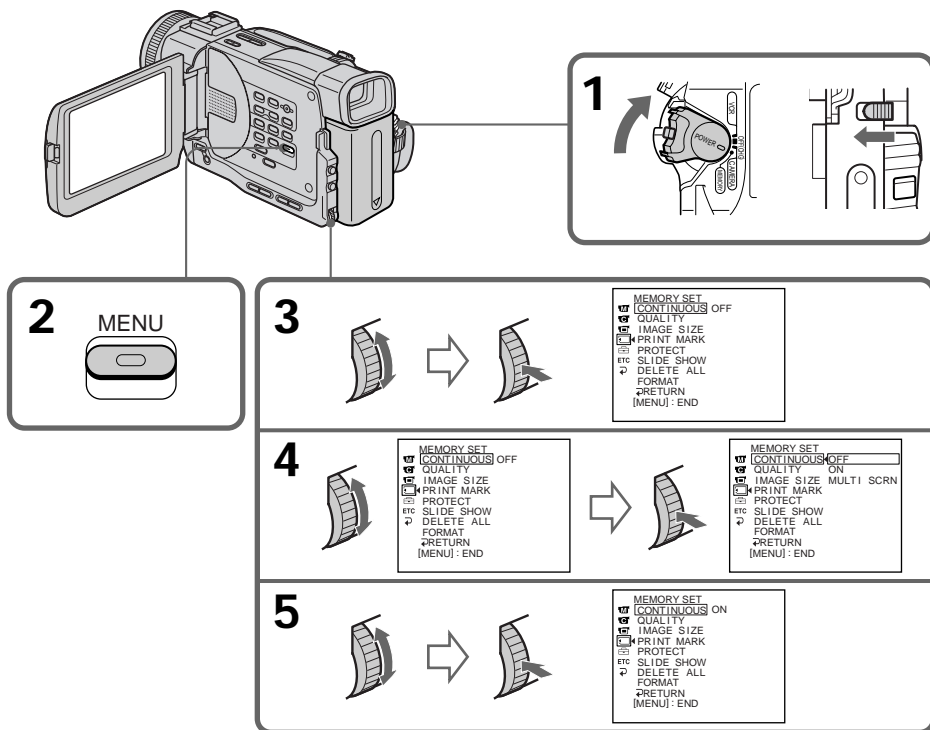

“Memory Stick” Operations

If the capacity of the “Memory Stick” becomes full

“ FULL” appears on the LCD screen or in the viewfinder, and you cannot record still pictures on this “Memory Stick.”

Continuous shooting settings

Setting	Meaning (indicator on the screen)
OFF	Your camcorder shoots one image at a time. (no indicator)
ON (DCR-TRV20 only)	Your camcorder shoots up to 16 still images at about 0.5 sec intervals. (
MULTI SCRN	Your camcorder shoots nine still images at about 0.5 sec intervals and displays the images on a single page divided into nine boxes. Still images are recorded in 640 × 480 size. (

The number of images in continuous shooting

The number of images you can shoot continuously varies depending on the image size and the capacity of the “Memory Stick.”

Image size	The number of images
640 × 480	up to 16 images
1152 × 864	up to 4 images

Recording still images on “Memory Stick”s – Memory photo recording

Note on using the video flash light (not supplied)

The video flash light does not work in the continuous or multi screen mode if you install it to the intelligent accessory shoe.

Self-timer memory photo recording

You can make a memory photo recording with the self-timer. This mode is useful when you want to record yourself.

- (1) Set the POWER switch to MEMORY. Make sure that the LOCK switch is set to the left (unlock) position.
- (2) Press SELFTIMER in the standby mode. The  (self-timer) indicator appears on the LCD screen or in the viewfinder.
- (3) Press PHOTO.

Self-timer starts counting down from 10 with a beep sound. In the last two seconds of the countdown, the beep sound gets faster, then recording starts automatically.

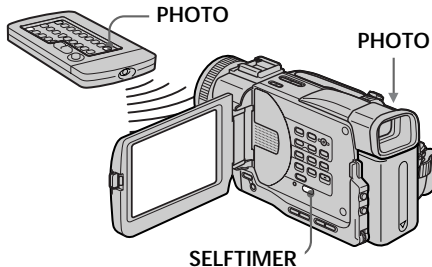

To cancel self-timer recording

Press SELFTIMER so that the  (self-timer) indicator disappears from on the LCD screen or in the viewfinder. You cannot cancel the self-timer recording using the Remote Commander.

Note

The self-timer recording mode is automatically canceled when:

- Self-timer recording is finished.
- The POWER switch is set to OFF (CHG) or VCR.

To check the picture to be recorded

You can check the picture with pressing the PHOTO button lightly, then press it deeper to capture.

Superimposing a still picture in a “Memory Stick” on a moving picture – MEMORY MIX

– DCR-TRV11/TRV20 only

You can superimpose a still picture you have recorded on a “Memory Stick” on the top of the moving picture you are recording.

M. CHROM (Memory chromakey)

You can swap a blue area of a still picture such as an illustration or a frame with a moving picture.

M. LUMI (Memory luminancekey)

You can swap a brighter area of a still picture such as a handwritten illustration or title with a moving picture. Record a title on a “Memory Stick” before a trip or event for convenience.

C. CHROM (Camera chromakey)

You can superimpose a moving picture on the top of a still picture such as a picture can be used as background. Shoot the subject against a blue background. The blue area of the moving picture will be swapped with a still picture.

M. OVERLAP (Memory overlap)

You can make a moving image fade in on top of a still image.

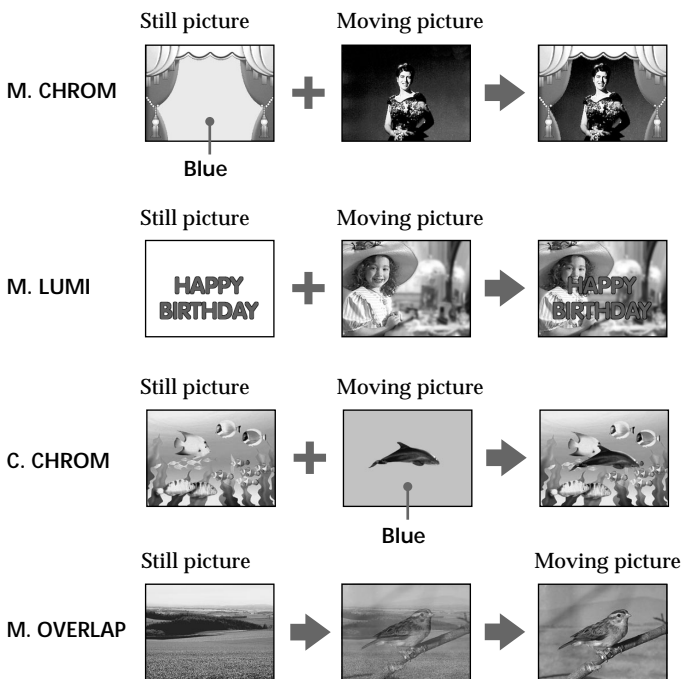

Superimposing a still picture in a “Memory Stick” on a moving picture – MEMORY MIX

Before operation

- Insert a mini DV tape for recording into your camcorder.
- Insert a recorded “Memory Stick” into your camcorder.

- (1) Set the POWER switch to CAMERA.
- (2) Press MEMORY MIX in the standby mode.
The last recorded or last composed image appears on the lower part of the screen as a thumbnail image.
- (3) Press MEMORY+/- to select the still picture you want to superimpose.
To see the previous image, press MEMORY -. To see the next image, press MEMORY+.
- (4) Turn the SEL/PUSH EXEC dial to select the desired mode.
The mode changes as follows:
M.CHROM → M.LUMI → C.CHROM → M. OVERLAP
- (5) Press the SEL/PUSH EXEC dial.
The still picture is superimposed on the moving picture. Your camcorder automatically returns to the standby mode.
- (6) Turn the SEL/PUSH EXEC dial to adjust the effect.
When M.OVERLAP is selected, no adjustment is necessary.
- (7) Press START/STOP to start recording.

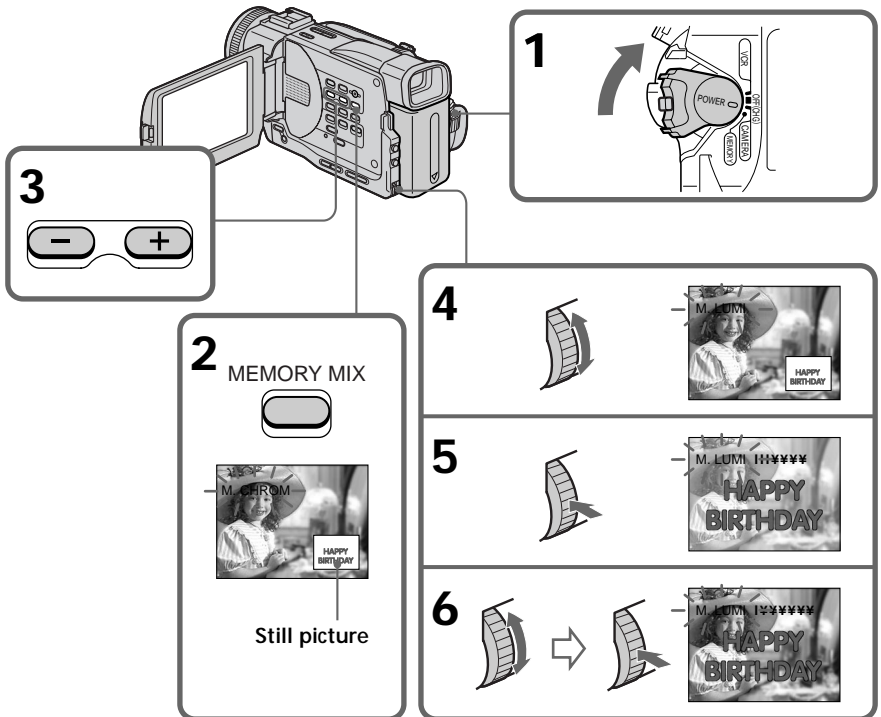

Superimposing a still picture in a “Memory Stick” on a moving picture – MEMORY MIX

Items to be adjusted

M. CHROM	The color (blue) scheme of the area in the still picture which is to be swapped with a moving picture
M. LUMI	The color (bright) scheme of the area in the still picture which is to be swapped with a moving picture
C. CHROM	The color (blue) scheme of the area in the moving picture which is to be swapped with a still picture
M. OVERLAP	No adjustment necessary

The fewer bars there are on the screen, the stronger the effect.

To change the still picture to be superimposed

Do either of the following:

- Press MEMORY+/- before step 6.
- Press the SEL/PUSH EXEC dial before step 6, and repeat the procedure from step 4.

To change the mode setting

Press the SEL/PUSH EXEC dial before step 6, and repeat the procedure from step 4.

To cancel M. CHROM/M. LUMI/C. CHROM/M. OVERLAP

Press MEMORY MIX again.

During recording

You cannot change the mode setting.

The “Memory Stick” supplied with your camcorder has stored 20 images

- For M.CHROM : 18 images (such as a frame) 100-0001 ~ 100-0018
- For C.CHROM : 2 images (such as a background) 100-0019 ~ 100-0020

Sample images

Sample images stored in the “Memory Stick” supplied with your camcorder are protected (p. 120).

If a still picture to be superimposed has lots of white areas

The thumbnail image may not be displayed clearly.

Image data modified with personal computers or shot with other equipment

You may not be able to play them back with your camcorder.

Note

When the overlapping still picture has a large amount of white, the thumbnail image of the picture may not be clear.

Recording an image from a mini DV tape as a still image

- DCR-TRV11/TRV20 only

Your camcorder can read moving picture data recorded on a mini DV tape and record it as a still image on a "Memory Stick".

Before operation

- Insert a recorded mini DV tape into your camcorder.
- Insert a "Memory Stick" into your camcorder.

- (1) Set the POWER switch to VCR.
- (2) Press **▶**. The picture recorded on the mini DV tape is played back.
- (3) Keep pressing **PHOTO** lightly until the picture from the mini DV tape freezes. "CAPTURE" appears on the LCD screen or in the viewfinder. Recording does not start yet.
- (4) Press **PHOTO** deeper. The image displayed on the screen will be recorded on a "Memory Stick." Recording is complete when the bar scroll indicator disappears.

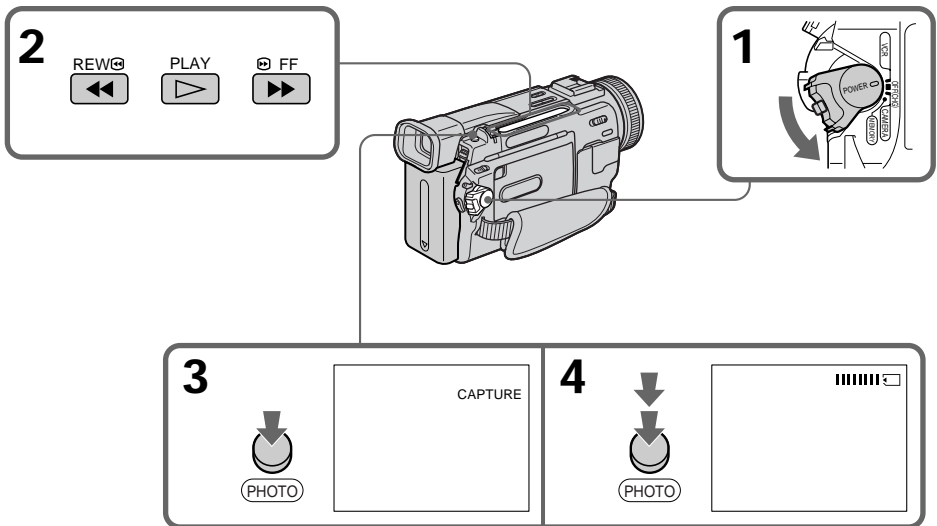

Image size of still pictures

Image size is automatically set to 640 × 480.

When the access lamp is lit or flashing

Never shake or strike the unit. As well do not turn the power off, eject a "Memory Stick" or remove the battery pack. Otherwise, the image data breakdown may occur.

If "⊠" appears on the LCD screen or in the viewfinder

The inserted "Memory Stick" is incompatible with your camcorder because its format does not conform with your camcorder. Check the format of the "Memory Stick."

If you press PHOTO lightly in the playback mode

Your camcorder stops momentarily.

Recording an image from a mini DV tape as a still image

Sound recorded on a mini DV tape

You cannot record the audio from a mini DV tape.

Titles have already recorded on mini DV tapes

You cannot record the titles on “Memory Stick”s. The title does not appear while you are recording a still picture with PHOTO.

When you press PHOTO on the Remote Commander

Your camcorder immediately records the image that is on the screen when you press the button.

Recording a still image from other equipment

- (1) Set the POWER switch to VCR and set DISPLAY in **[ETC]** to LCD in the menu settings.
Set A/V → DV OUT in **[V]** to OFF in the menu settings.
- (2) Play back the recorded tape, or turn the TV on to see the desired program.
The image of the other equipment is displayed on the LCD screen or in the viewfinder.
- (3) Follow steps 3 and 4 on page 108.

When recording the image through the AUDIO/VIDEO jack

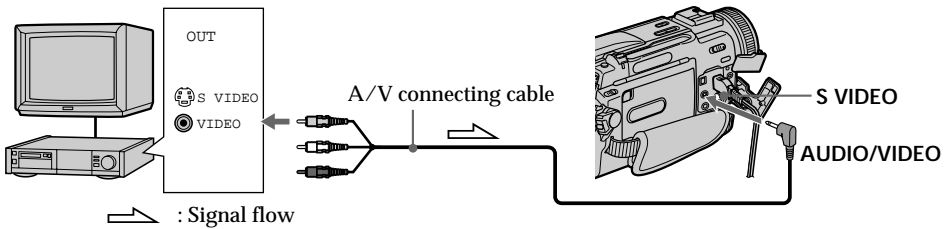

Connect the yellow plug of the A/V connecting cable to the video jack on the VCR or the TV.

Recording an image from a mini DV tape as a still image

When recording the image through the **i** DV IN/OUT jack

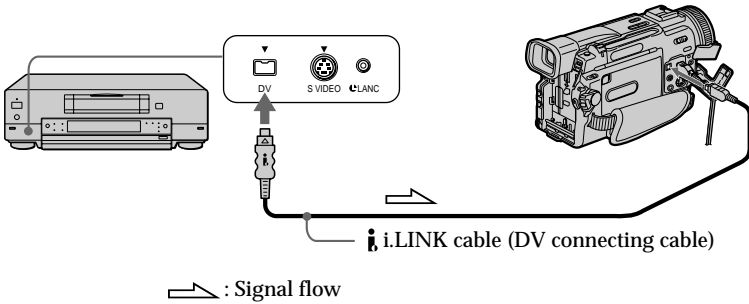

Connect using an S video cable (not supplied) to obtain high-quality pictures

With this connection, you do not need to connect the yellow (video) plug of the A/V connecting cable.

Connect an S video cable (not supplied) to the S video jacks of both your camcorder and the VCR.

This connection produces higher quality DV format pictures.

Copying still images from a mini DV tape – Photo save

– DCR-TRV11/TRV20 only

Using the search function, you can automatically take in only still images from mini DV tapes and record them on a “Memory Stick” in sequence.

Before operation

- Insert a recorded mini DV tape into your camcorder and rewind the tape.
- Insert a “Memory Stick” into your camcorder.

- (1) Set the POWER switch to VCR.
- (2) Press MENU to display the menu.
- (3) Turn the SEL/PUSH EXEC dial to select , then press the dial.
- (4) Turn the SEL/PUSH EXEC dial to select PHOTO SAVE, then press the dial. “PHOTO BUTTON” appears on the LCD screen or in the viewfinder.
- (5) Press PHOTO deeper. The still image from the mini DV tape is recorded on a “Memory Stick.” The number of still images copied is displayed. “END” is displayed when copying is completed.

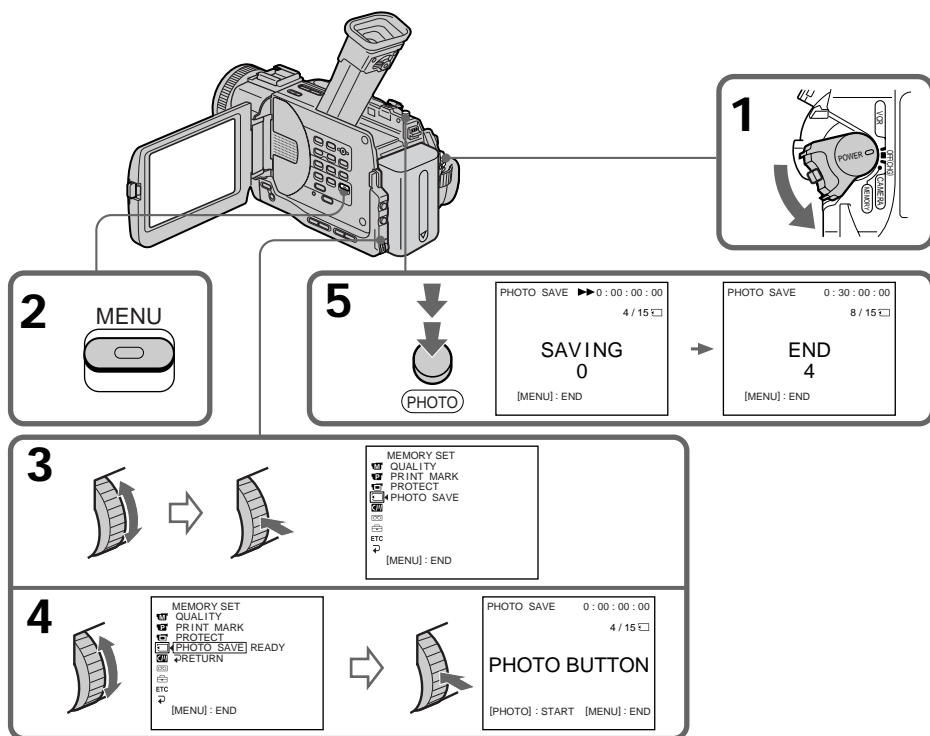

Copying still images from a mini DV tape - Photo save

To stop or end copying

Press MENU.

When the memory of the “Memory Stick” is full

“MEMORY FULL” appears on the LCD screen or in the viewfinder, and the copying stops. Insert another “Memory Stick” and repeat the procedure from step 2.

Image size of still pictures

Image size is automatically set to 640 × 480.

When the access lamp is lit or flashing

Never shake or strike your camcorder. As well do not turn the power off, eject a “Memory Stick” or remove the battery pack. Otherwise, the image data breakdown may occur.

To record all the images recorded on the mini DV tape

Rewind the tape all the way back and start copying.

If the write-protect tab on the “Memory Stick” is set to LOCK

“NOT READY” appears when you select the item in the menu settings.

When you change “Memory Stick”s in the middle of copying

Your camcorder resumes copying from the last image recorded on the previous “Memory Stick.”

Viewing a still picture – Memory photo playback

– DCR-TRV11/TRV20 only

You can play back still images recorded on a “Memory Stick.” You can also play back six images at a time by selecting the index screen.

Before operation

Insert a “Memory Stick” into your camcorder.

(1) Set the POWER switch to MEMORY or VCR.

Make sure that the LOCK switch is set to the left (unlock) position.

(2) Press MEMORY PLAY. The last recorded image is displayed.

(3) Press MEMORY +/- to select the desired still image. To see the previous image, press MEMORY -. To see the next image, press MEMORY +.

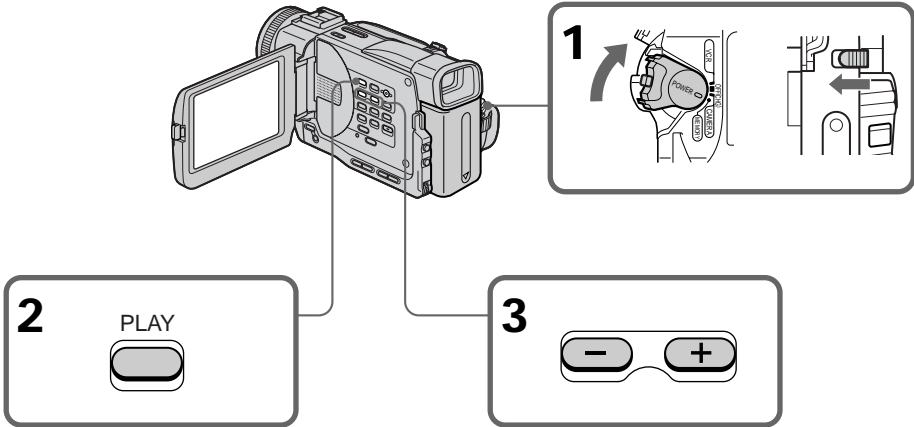

To stop memory photo playback

Press MEMORY PLAY again.

To play back recorded images on a TV screen

- Connect your camcorder to the TV with the A/V connecting cable supplied with your camcorder before operation.
- When operating memory photo playback on a TV or on the LCD screen, the image quality may appear to have deteriorated. This is not a malfunction. The image data is as good as ever.
- Turn the audio volume of the TV down before operation, or noise (howling) may be output from the TV speakers.
- The message “ NO FILE” appears when no image is recorded on the “Memory Stick”.

Recording date

When you press DATA CODE, you can see the date of the recording.

Image data modified with personal computers or shot with other equipment

You may not be able to play them back with your camcorder.

Viewing a still picture – Memory photo playback

Screen indicators during still image playback

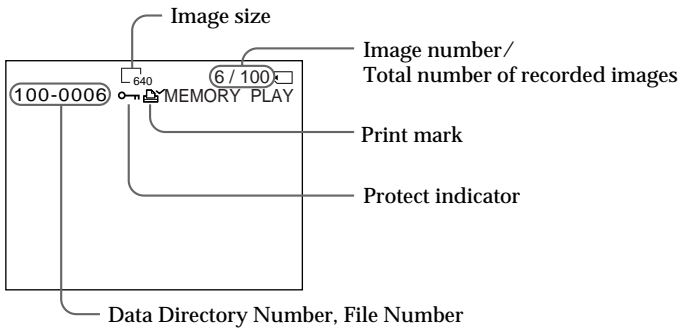

Playing back six recorded images at a time (index screen)

You can play back six recorded images at a time. This function is especially useful when searching for a particular image.

- (1) Set the POWER switch to MEMORY or VCR. Make sure that the LOCK switch is set to the left (unlock) position.
- (2) Press MEMORY INDEX to display the index screen.

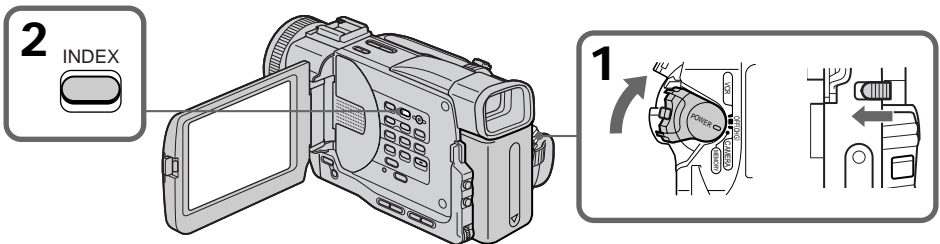

A red ► mark appears above the image that is displayed before changing to the index screen mode.

MEMORY - : to display the previous six images
MEMORY + : to display the following six images

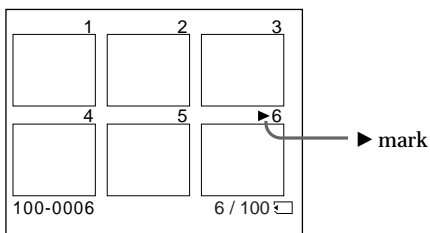

Viewing a still picture - Memory photo playback

To return to the normal playback screen (single screen)

Press MEMORY +/- to move the ► mark to the image you want to display on full screen, then press MEMORY PLAY.

Note

When displaying the index screen, the number appears above each image. This indicates the order in which images are recorded on the "Memory Stick." These numbers are different from the data file names.

Files modified with personal computers

These files may not be displayed on the index screen. Image files shot with other equipment may not be displayed on the index screen either.

To make the display disappear

Press DISPLAY.

Viewing the recorded images using a personal computer

The image data recorded with your camcorder is compressed in the JPEG format. If you use the application software, "PictureGear 4.1Lite" supplied with your camcorder, you can see images recorded on the "Memory Stick" on a computer screen. Use the PC serial cable supplied with your camcorder for this operation. You can playback the images on the "Memory Stick"s on the computer screen only in the memory mode.

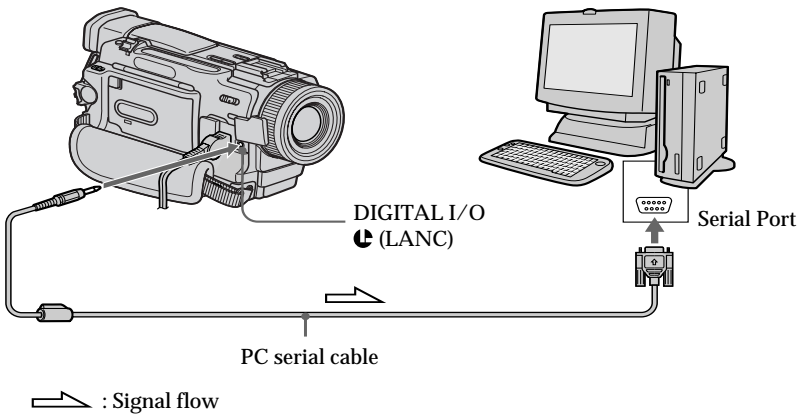

Copying the image recorded on "Memory Stick"s to mini DV tapes

- DCR-TRV11/TRV20 only

You can copy still images or titles recorded on "Memory Stick" and record them to a mini DV tape.

Before operation

- Insert mini DV tape for recording into your camcorder.
- Insert a "Memory Stick" into your camcorder.

- (1) Set the POWER switch to VCR.
- (2) Using the video control buttons, search a point where you want to record the desired still image. Set the mini DV tape to playback pause.
- (3) Press ● REC and the button on its right simultaneously on your camcorder. The mini DV tape is set to the recording pause mode.
- (4) Press MEMORY PLAY to play back the still image you want to copy.
- (5) Press ■ to start recording and press ■ again to stop.
- (6) If you have more to copy, repeat steps 4 and 5.

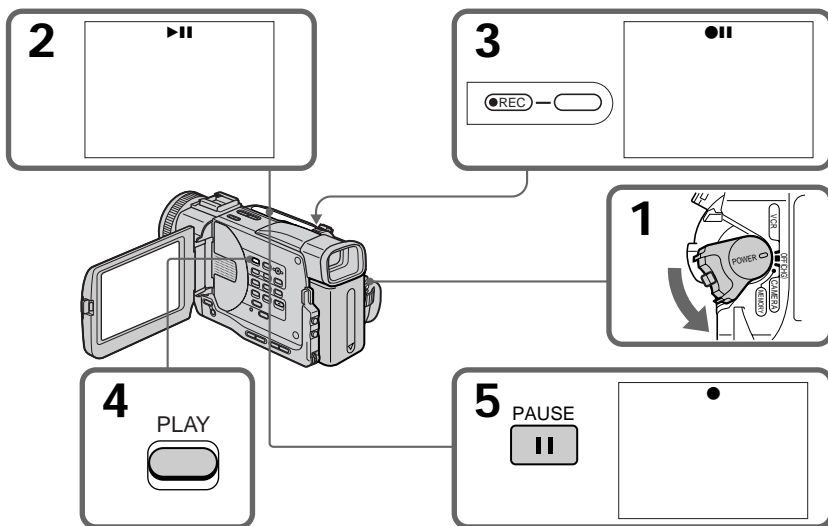

To stop copying in the middle

Press ■.

During copying

You cannot operate the following buttons:

MEMORY PLAY, MEMORY INDEX, MEMORY DELETE, MEMORY +, MEMORY - and MEMORY MIX.

Copying the image recorded on "Memory Stick"s to mini DV tapes

Note on the index screen

You cannot record the index screen.

If you press EDITSEARCH during pause mode

Memory playback stops.

Image data modified with personal computers or shot with other equipment

You may not be able to copy them with your camcorder.

If you press DISPLAY in the standby or recording mode

You can see memory playback and the file name indicators in addition to the indicators pertinent to mini DV tapes, such as the time code indicator.

Enlarging still images recorded on “Memory Stick”s – Memory PB ZOOM

- DCR-TRV11/TRV20 only

You can enlarge still images recorded on a “Memory Stick”.

Before operation

Insert a “Memory Stick” into your camcorder.

- (1) In the memory playback mode, press PB ZOOM on your camcorder.
The still image is enlarged, and $\uparrow \downarrow \leftarrow \rightarrow$ appears on the LCD screen or in the viewfinder.
- (2) Turn SEL/PUSH EXEC dial to move the enlarged image, then press the dial.
 \uparrow : The image moves downwards
 \downarrow : The image moves upwards
- (3) Turn SEL/PUSH EXEC dial to move the enlarged image, then press the dial.
 \rightarrow : The image moves leftward (Turn the dial to upwards.)
 \leftarrow : The image moves rightward (Turn the dial to downwards.)

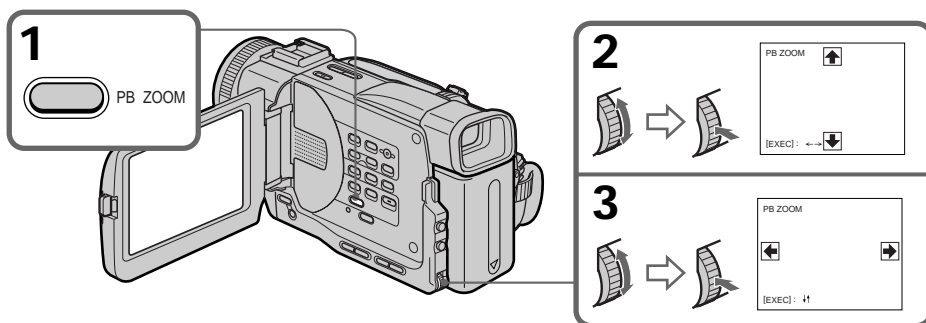

To cancel the play zoom function

Press PB ZOOM again.

Note

You cannot record the images enlarged by the PB ZOOM mode on “Memory Stick”s.

The PB ZOOM function is cancelled when the following buttons are pressed:

- MENU
- MEMORY PLAY
- MEMORY INDEX

In the PB ZOOM mode

The digital effect function does not work.

Pictures in the PB ZOOM mode

Pictures in the PB ZOOM mode are not output through the \mathbb{I} DV IN/OUT jack.

Playing back images in a continuous loop – SLIDE SHOW

– DCR-TRV11/TRV20 only

You can automatically play back images in sequence. This function is useful especially when checking recorded images or during a presentation.

Before operation

Insert a “Memory Stick” into your camcorder.

- (1) Set the POWER switch to MEMORY. Make sure that the LOCK switch is set to the left (unlock) position.
- (2) Press MENU to display the menu.
- (3) Turn the SEL/PUSH EXEC dial to select , then press the dial.
- (4) Turn the SEL/PUSH EXEC dial to select SLIDE SHOW, then press the dial.
- (5) Press MEMORY PLAY. Your camcorder plays back the images recorded on a “Memory Stick” in sequence.

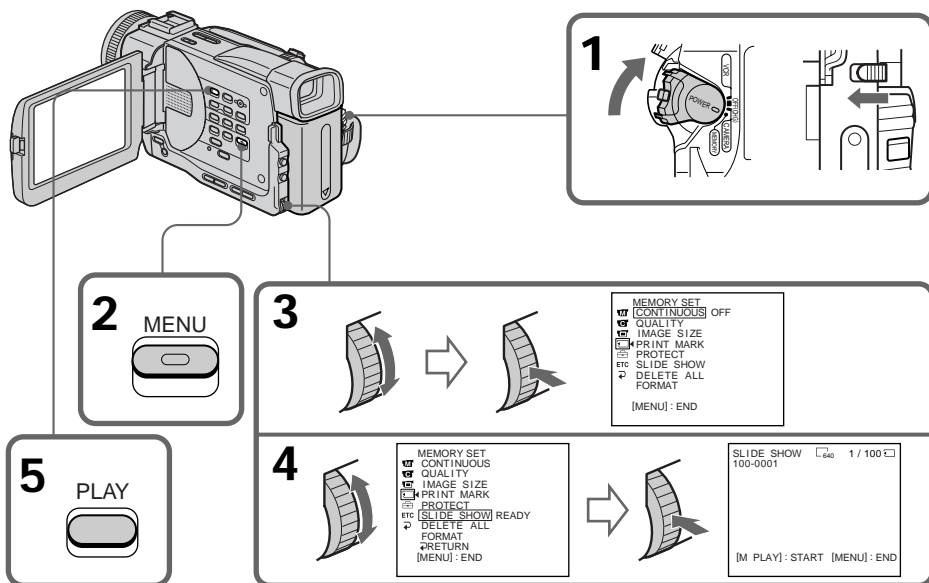

“Memory Stick” Operations

To stop or end the slide show

Press MENU.

To pause during a slide show

Press MEMORY PLAY.

To start the slide show from a particular image

Select the desired image using MEMORY +/- buttons before step 2.

To view the recorded images on TV

Connect your camcorder to a TV with the A/V connecting cable supplied with your camcorder before operation.

If you change the “Memory Stick” during operation

The slide show does not operate. If you change the “Memory Stick,” be sure to follow the steps again from the beginning.



Preventing accidental erasure – Image protection

– DCR-TRV11/TRV20 only





To prevent accidental erasure of important images, you can protect selected images.

Before operation

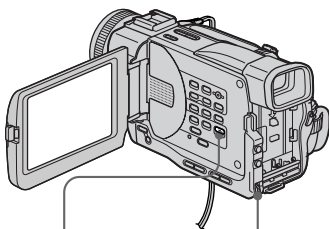
Insert a “Memory Stick” into your camcorder.

- (1) Set the POWER switch to MEMORY or VCR. Make sure that the LOCK switch is set to the left (unlock) position.
- (2) Play back the image you want to protect.
- (3) Press MENU to display the menu.
- (4) Turn the SEL/PUSH EXEC dial to select , then press the dial.
- (5) Turn the SEL/PUSH EXEC dial to select PROTECT, then press the dial.
- (6) Turn the SEL/PUSH EXEC dial to select ON, then press the dial.
- (7) Press MENU to make the menu display disappear. The “” mark is displayed beside the data file name of the protected image.



3,7 MENU 	4  MEMORY SET 10 / 12 □ CONTINUOUS QUALITY IMAGE SIZE PRINT MARK PROTECT SLIDE SHOW etc. DELETE ALL FORMAT RETURN [MENU] : END
	5  MEMORY SET 10 / 12 □ CONTINUOUS QUALITY IMAGE SIZE PRINT MARK PROTECT OFF SLIDE SHOW etc. DELETE ALL FORMAT RETURN [MENU] : END → MEMORY SET 10 / 12 □ CONTINUOUS QUALITY IMAGE SIZE PRINT MARK PROTECT ON SLIDE SHOW etc. DELETE ALL FORMAT RETURN [MENU] : END
	6  MEMORY SET 10 / 12 □ CONTINUOUS QUALITY IMAGE SIZE PRINT MARK PROTECT ON SLIDE SHOW etc. DELETE ALL FORMAT RETURN [MENU] : END

To cancel image protection

Select OFF in step 6, then press the SEL/PUSH EXEC dial.

Note

Formatting erases all information on the “Memory Stick,” including the protected image data. Check the contents of the “Memory Stick” before formatting.

If the write-protect tab on the “Memory Stick” is set to LOCK
You cannot carry out image protection.

Deleting images

– DCR-TRV11/TRV20 only

Deleting selected images

Before operation

Insert a “Memory Stick” into your camcorder.

- (1) Set the POWER switch to MEMORY or VCR. Make sure that the LOCK switch is set to the left (unlock) position.
- (2) Play back the image you want to delete (p. 113).
- (3) Press MEMORY DELETE with a sharp-pointed object. “DELETE?” appears on the LCD screen or in the viewfinder.
- (4) Press MEMORY DELETE again. The selected image is deleted.

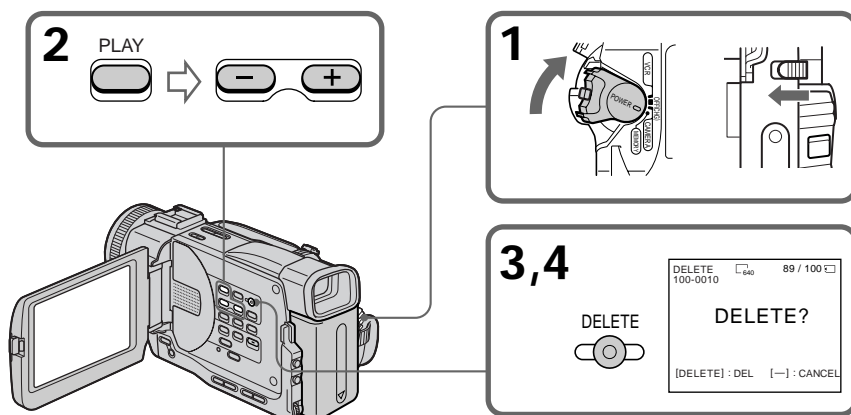

“Memory Stick” Operations

To cancel deleting an image

Press MEMORY – in step 4.

To delete an image displayed on the index screen

Press MEMORY +/- to move the ► indicator to the desired image and follow steps 3 and 4.

Notes

- To delete a protected image, first cancel image protection.
- Once you delete an image, you cannot restore it. Check the images to delete carefully before deleting them.
- You cannot delete images if the write-protect tab on a “Memory Stick” is set to LOCK.

Deleting images

Deleting all the images

You can delete all the unprotected images in a “Memory Stick.”

Before operation

Insert a “Memory Stick” into your camcorder.

- (1) Set the POWER switch to MEMORY. Make sure that the LOCK switch is set to the left (unlock) position.
- (2) Press MENU to display the menu.
- (3) Turn the SEL/PUSH EXEC dial to select , then press the dial.
- (4) Turn the SEL/PUSH EXEC dial to select DELETE ALL, then press the dial.
- (5) Turn the SEL/PUSH EXEC dial to select OK, then press the dial. “OK” changes to “EXECUTE.”
- (6) Turn the SEL/PUSH EXEC dial to select EXECUTE, then press the dial. “DELETING” appears on the LCD screen or in the viewfinder. When all the unprotected images are deleted, “COMPLETE” is displayed.

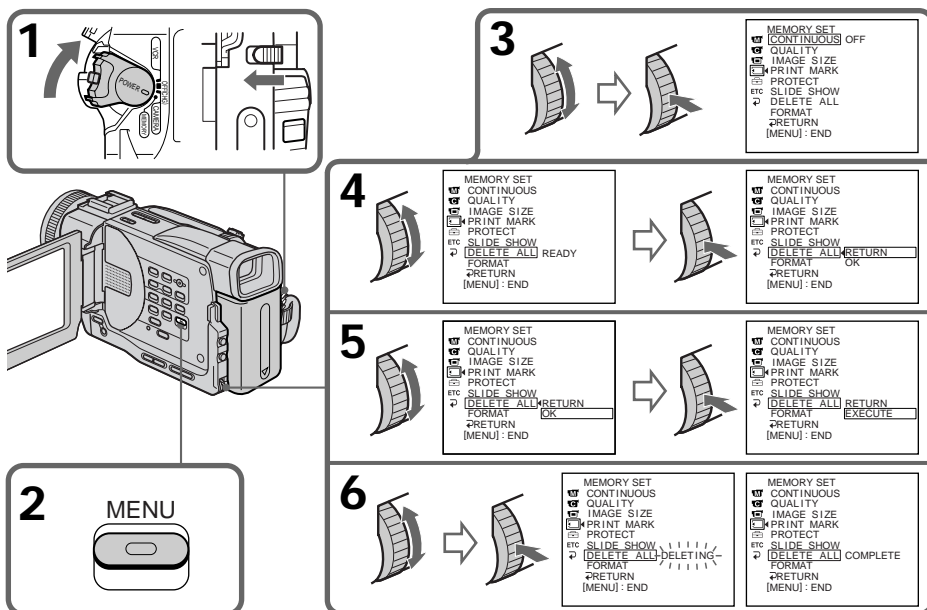

To cancel deleting all the images in the “Memory Stick”

Select  RETURN in step 5, then press the SEL/PUSH EXEC dial.

While “DELETING” appears

Do not turn the POWER switch or press any buttons.

Writing a print mark – PRINT MARK



– DCR-TRV11/TRV20 only

You can specify the recorded still image to print out. This function is useful for printing out still images later.

Your camcorder conforms with the DPOF (Digital Print Order Format) standard for specifying the still images to print out.

Before operation

Insert a “Memory Stick” into your camcorder.

- (1) Set the POWER switch to MEMORY or VCR. Make sure that the LOCK switch is set to the left (unlock) position.
- (2) Play back the image to be printed out.
- (3) Press MENU to display the menu.
- (4) Turn the SEL/PUSH EXEC dial to select , then press the dial.
- (5) Turn the SEL/PUSH EXEC dial to select PRINT MARK, then press the dial.
- (6) Turn the SEL/PUSH EXEC dial to select ON, then press the dial.
- (7) Press MENU to make the menu display disappear. The “” mark is displayed beside the data file name of the image with a print mark.

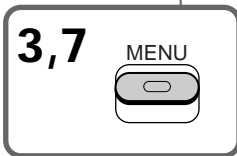
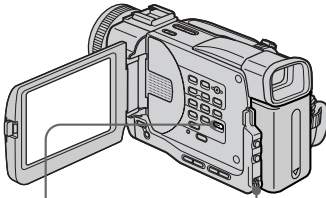

4



MEMORY SET
CONTINUOUS OFF
QUALITY
IMAGE SIZE
PRINT MARK
PROTECT
etc SLIDE SHOW
DELETE ALL
FORMAT
RETURN
[MENU]: END

5



MEMORY SET 10 / 12
CONTINUOUS
QUALITY
IMAGE SIZE
PRINT MARK OFF
PROTECT
etc SLIDE SHOW
DELETE ALL
FORMAT
RETURN
[MENU]: END



MEMORY SET 10 / 12
CONTINUOUS
QUALITY
IMAGE SIZE
PRINT MARK ON
PROTECT
etc SLIDE SHOW
DELETE ALL
FORMAT
RETURN
[MENU]: END

6



MEMORY SET 10 / 12
CONTINUOUS
QUALITY
IMAGE SIZE
PRINT MARK ON
PROTECT
etc SLIDE SHOW
DELETE ALL
FORMAT
RETURN
[MENU]: END

To cancel writing print marks

Select OFF in step 6, then press the SEL/PUSH EXEC dial.

If the write-protect tab on the “Memory Stick” is set to LOCK
You cannot write print marks on still images.

Usable cassettes

Selecting cassette types

You can use the **Mini DV** mini DV cassette only*. You cannot use any other **8** 8 mm, **Hi8** Hi8, **D** Digital8, **VHS** VHS, **VHS-C** VHSC, **S-VHS** S-VHS, **S-VHS-C** S-VHSC, **B** Betamax, **ED Beta** ED Betamax or **DV** DV cassette.

* There are two types of mini DV cassettes: with cassette memory and without cassette memory. Tapes with cassette memory have **CM** (Cassette Memory) mark. We recommend you to use the tape with cassette memory.

The IC memory is mounted on this type of mini DV cassette. Your camcorder can read and write data such as dates of recording or titles, etc. to this memory.

The functions using the cassette memory require successive signals recorded on the tape. If the tape has a blank portion in the beginning or between the recorded portions, a title may not be displayed properly or the search functions may not work properly. Not to make any blank portion on the tape, operate the followings.

Press END SEARCH to go to the end of the recorded portion before you begin the next recording if you operate the followings:

- you have ejected the cassette while recording.
- you have played back the tape in the VCR.
- you have used the edit search function.

If there is a blank portion or discontinuous signal on your tape, re-record from the beginning to the end of the tape concerning above.

The same result may occur when you record using a digital video camera recorder without a cassette memory function on a tape recorded by one with the cassette memory function.

CM 4K mark on the cassette

The memory capacity of tapes marked with **CM** 4K is 4KB. Your camcorder can accommodate tapes having a memory capacity of up to 16KB. 16KB tape is marked with **CM** 16K.

Mini DV Digital Video Cassette This is the Mini DV mark.

CM Cassette Memory This is the Cassette Memory mark.

These are trademarks.

When you play back

Copyright signal

When you play back

Using any other video camera recorder, you cannot record on tape that has recorded a copyright control signals for copyright protection of software which is played back on your camcorder.

When you record

You cannot record software on your camcorder that contains copyright control signals for copyright protection of software.

“COPY INHIBIT” appears on the LCD screen, in the viewfinder or on the TV screen if you try to record such software.

Your camcorder does not record copyright control signals on the tape when it records.

Usable cassettes

Audio mode

12-bit mode: The original sound can be recorded in stereo 1, and the new sound in stereo 2 in 32 kHz. The balance between stereo 1 and stereo 2 can be adjusted by selecting AUDIO MIX in the menu settings during playback. Both sounds can be played back.

16-bit mode: A new sound cannot be recorded but the original sound can be recorded in high quality. Moreover, it can also play back sound recorded in 32 kHz, 44.1 kHz or 48 kHz. When playing back a tape recorded in the 16-bit mode, 16BIT indicator appears on the LCD screen or in the viewfinder.

When you play back a dual sound track tape

When you play back a dual sound track tape recorded in a stereo system, set “HiFi SOUND” to the desired mode in the menu settings (p. 85).

Sound from speaker

HiFi SOUND mode	Playing back a stereo tape	Playing back a dual sound track tape
STEREO	Stereo	Main sound and sub sound
1	Left sound	Main sound
2	Right sound	Sub sound

You cannot record dual sound programs on your camcorder.

Notes on the mini DV cassette

When affixing a label on the mini DV cassette

Be sure to affix a label only on the locations as illustrated below [a] so as not to cause malfunction of your camcorder.

After using the mini DV cassette

Rewind the tape to the beginning, put the cassette in its case, and store it in an upright position.

When the cassette memory function does not work

Reinsert a cassette. The gold-plated connector of mini DV cassettes may be dirty or dusty.

Cleaning gold-plated connector

If the gold-plated connector of mini DV cassettes is dirty or dusty, you may not operate the function using cassette memory. Clean up the gold-plated connector with cotton-wool swab, about every 10 times ejection of a cassette. [b]

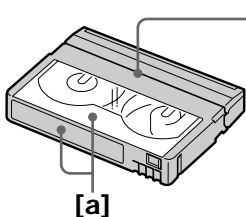

Do not affix a label around this border.

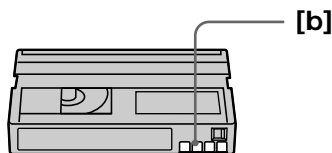

About i.LINK

The DV jack on this unit is an i.LINK-compliant DV input/output jack. This section describes the i.LINK standard and its features.

What is i.LINK?

i.LINK is a digital serial interface for handling digital video, digital audio and other data in two directions between equipment having the i.LINK jack, and for controlling other equipment.

i.LINK-compatible equipment can be connected by a single i.LINK cable. Possible applications are operations and data transactions with various digital AV equipment. When two or more i.LINK-compatible equipment are connected to this unit in a daisy chain, operations and data transactions are possible with not only the equipment that this unit is connected to but also with other devices via the directly connected equipment.

Note, however, that the method of operation sometimes varies according to the characteristics and specifications of the equipment to be connected, and that operations and data transactions are sometimes not possible on some connected equipment.

Note

Normally, only one piece of equipment can be connected to this unit by the i.LINK cable (DV cable). When connecting this unit to i.LINK-compatible equipment having two or more i.LINK jacks (DV jacks), refer to the instruction manual of the equipment to be connected.

About the Name “i.LINK”

i.LINK is a more familiar term for IEEE 1394 data transport bus proposed by SONY, and is a trademark approved by many corporations. IEEE 1394 is an international standard standardized by the Institute of Electrical and Electronic Engineers.

i.LINK Baud rate

i.LINK's maximum baud rate varies according to the equipment. Three maximum baud rates are defined:

- S100 (approx. 100Mbps*)
- S200 (approx. 200Mbps)
- S400 (approx. 400Mbps)

The baud rate is listed under “Specifications” in the instruction manual of each equipment. It is also indicated near the i.LINK jack on some equipment. The maximum baud rate of equipment on which it is not indicated such as this unit is “S100”.

When units are connected to equipment having a different maximum baud rate, the baud rate sometimes differs from the indicated baud rate.

*What is Mbps?

Mbps stands for megabits per second, or the amount of data that can be sent or received in one second. For example, a baud rate of 100Mbps means that 100 megabits of data can be sent in one second.

About i.LINK

i.LINK functions on this unit

For details on how to dub when this unit is connected to other video equipment having DV jacks, see page 55, 69.

This unit can also be connected to other i.LINK (DV) compatible equipment made by SONY (e.g. VAIO series personal computer) other than video equipment.

Before connecting this unit to a personal computer, make sure that application software supported by this unit is already installed on the personal computer.

For details on precautions when connecting this unit, also refer to the instruction manuals for the equipment to be connected.

Required i.LINK Cable

Use the Sony i.LINK 4-pin-to-4-pin cable (during DV dubbing).

i.LINK and  are trademarks.

Troubleshooting

If you run into any problem using your camcorder, use the following table to troubleshoot the problem. If the problem persists, disconnect the power source and contact your Sony dealer or local authorized Sony service facility. If “C:□□:□□” appears on the LCD screen or in the viewfinder, the self-diagnosis display function has worked. See page 134.

In the recording mode

Symptom	Cause and/or Corrective Actions
START/STOP does not operate.	<ul style="list-style-type: none"> • The POWER switch is not set to CAMERA. → Set it to CAMERA. (p. 16) • The tape has run out. → Rewind the tape or insert a new one. (p. 15, 27) • The write-protect tab is set to expose the red mark. → Use a new tape or slide the tab. (p. 15) • The tape is stuck to the drum (moisture condensation). → Remove the cassette and leave your camcorder for at least one hour to acclimatize. (p. 138)
The power goes off.	<ul style="list-style-type: none"> • While being operated in CAMERA mode, your camcorder has been in the standby mode for more than five minutes. → Set the POWER switch to OFF (CHG) and then to CAMERA again. (p. 17)
The image on the viewfinder screen is not clear.	<ul style="list-style-type: none"> • The viewfinder lens is not adjusted. → Adjust the viewfinder lens. (p. 19)
The SteadyShot function does not work.	<ul style="list-style-type: none"> • STEADYSHOT is set to OFF in the menu settings. → Set it to ON. (p. 85)
The autofocus function does not work.	<ul style="list-style-type: none"> • FOCUS is set to MAN. → Set it to AUTO. (p. 44) • Shooting conditions are not suitable for autofocus. → Adjust to focus manually. (p. 44)
The fader function does not work.	<ul style="list-style-type: none"> • The digital effect function is working. → Cancel it. (p. 39)
The picture does not appear in the viewfinder.	<ul style="list-style-type: none"> • The LCD panel is open. → Close the LCD panel. (p. 17)
A vertical band appears when you shoot a subject such as lights or a candle flame against a dark background.	<ul style="list-style-type: none"> • The contrast between the subject and background is too high. Your camcorder is not a malfunction.
A vertical band appears when you shoot a very bright subject.	<ul style="list-style-type: none"> • Your camcorder is not a malfunction.
Some tiny white spots appear on the LCD screen or in the viewfinder.	<ul style="list-style-type: none"> • Slow shutter, low lux or Super NightShot mode is activated. This is not a malfunction.
An unknown picture is displayed on the LCD screen or in the viewfinder.	<ul style="list-style-type: none"> • If 10 minutes elapse after you set the POWER switch to CAMERA or DEMO MODE is set to ON in the menu settings without a cassette inserted, your camcorder automatically starts the demonstration. → Insert a cassette and the demonstration stops. You can also cancel DEMO MODE. (p. 90)

Troubleshooting

Symptom	Cause and/or Corrective Actions
The picture is recorded in incorrect or unnatural colors.	<ul style="list-style-type: none"> • NIGHTSHOT is set to ON. → Set it to OFF. (p. 22)
Picture appears too bright, and the subject does not appear on the LCD screen or in the viewfinder.	<ul style="list-style-type: none"> • NIGHTSHOT is set to ON in a bright place. → Set it to OFF, or use the NightShot function in a dark place. (p. 22)
The click of the shutter does not sound.	<ul style="list-style-type: none"> • BEEP is set to OFF in the menu settings. → Set it to MELODY or NORMAL. (p. 85)
Black bands appear when you record TV or computer screen.	<ul style="list-style-type: none"> → Set the STEADYSHOT in the menu settings to OFF. (p. 85)





In the playback mode

Symptom	Cause and/or Corrective Actions
The tape does not move when a video control button is pressed.	<ul style="list-style-type: none"> • The POWER switch is not set to VCR. → Set it to VCR. (p. 25)
The playback button does not work.	<ul style="list-style-type: none"> • The tape has run out. → Rewind the tape. (p. 27)
The playback picture is not clear or does not appear.	<ul style="list-style-type: none"> • The television's video channel is not adjusted correctly. → Adjust it. (p. 28)
There are horizontal lines on the picture or the playback picture is not clear or does not appear.	<ul style="list-style-type: none"> • The video head may be dirty. → Clean the heads using the cleaning cassette (not supplied). (p. 138)
No sound or only a low sound is heard when playing back a tape.	<ul style="list-style-type: none"> • The volume is turned to minimum. → Turn up the volume. (p. 25) • AUDIO MIX is set to ST2 in the menu settings. → Adjust AUDIO MIX. (p. 85)
Displaying the recorded date, date search function does not work.	<ul style="list-style-type: none"> • The tape has no cassette memory. → Use a tape with cassette memory. (p. 50, 124) • CM SEARCH is set to OFF in the menu settings. → Set it to ON. (p. 85) • The tape has a blank portion in the recorded portion. (p. 50)
The title search function does not work.	<ul style="list-style-type: none"> • The tape has no cassette memory. → Use a tape with cassette memory. (p. 49, 124) • CM SEARCH is set to OFF in the menu settings. → Set it to ON. (p. 85) • There is no title in the tape. → Superimpose the titles. (p. 77) • The tape has a blank portion in the recorded portion. (p. 49)
The new sound added to the recorded tape is not heard.	<ul style="list-style-type: none"> • AUDIO MIX is set to ST1 side in the menu settings. → Adjust AUDIO MIX. (p. 85)
The title is not displayed.	<ul style="list-style-type: none"> • TITLE DSPL is set to OFF in the menu settings. → Set it to ON. (p. 85)

(continued on the following page)

Troubleshooting

In the recording and playback modes

Symptom	Cause and/or Corrective Actions
The power does not turn on.	<ul style="list-style-type: none">• The battery pack is not installed, or is dead or nearly dead. → Install a charged battery pack. (p. 10, 11)• The AC power adaptor is not connected to a wall outlet. → Connect the AC power adaptor to a wall outlet. (p. 14)
The end search function does not work.	<ul style="list-style-type: none">• The tape was ejected after recording when using a tape without cassette memory. (p. 24, 27)• You have not recorded on the new cassette yet. (p. 24, 27)
The end search function does not work correctly.	<ul style="list-style-type: none">• The tape has a blank portion in the beginning or middle.
The battery pack is quickly discharged.	<ul style="list-style-type: none">• The operating temperature is too low.• The battery pack is not fully charged. → Charge the battery pack again. (p. 11)• The battery pack is completely dead, and cannot be recharged. → Replace with a new battery pack. (p. 10)
The battery remaining indicator does not indicate the correct time.	<ul style="list-style-type: none">• You have used the battery pack in an extremely hot or cold environment for a long time.• The battery pack is completely dead, and cannot be recharged. → Replace with a new battery pack. (p. 10)• The battery is dead. → Use a charged battery pack. (p. 10, 11)
The power goes off although the battery remaining indicator indicates that the battery pack has enough power to operate.	<ul style="list-style-type: none">→ Charge the battery pack fully again so that the indication on the battery remaining indicator is correct.
The cassette cannot be removed from the holder.	<ul style="list-style-type: none">• The power source is disconnected. → Connect it firmly. (p. 10, 14)• The battery is dead. → Use a charged battery pack. (p. 10, 11)
The  and  indicators flash and no functions except for cassette ejection work.	<ul style="list-style-type: none">• Moisture condensation has occurred. → Remove the cassette and leave your camcorder for at least one hour to acclimatize. (p. 138)
 indicator does not appear when using a tape with cassette memory.	<ul style="list-style-type: none">• The gold-plated connector of the tape is dirty or dusty. → Clean the gold-plated connector. (p. 125)
Remaining tape indicator is not displayed.	<ul style="list-style-type: none">• The  REMAIN is set to AUTO in the menu settings. → Set it to ON to always display the remaining tape indicator. (p. 85)

Troubleshooting

When operating using the “Memory Stick”

– DCR-TRV11/TRV20 only

Symptom	Cause and/or Corrective Actions
The “Memory Stick” does not function.	<ul style="list-style-type: none">• The POWER switch is not set to MEMORY. → Set it to MEMORY. (p. 100)
Recording does not function.	<ul style="list-style-type: none">• The “Memory Stick” has already been recorded to its full capacity. → Erase unnecessary images and record again. (p. 121)• The “Memory Stick” is not inserted. → Insert a “Memory Stick”. (p. 95)• The “Memory Stick” formatted incorrectly is inserted. → Format the “Memory Stick” or use another “Memory Stick.” (p. 88)• The write-protect tab on the “Memory Stick” is set to LOCK. → Set the tab to write. (p. 93)
The image cannot be deleted.	<ul style="list-style-type: none">• The image is protected. → Cancel image protection. (p. 120)• The write-protect tab on the “Memory Stick” is set to LOCK. → Set the tab to write. (p. 93)
You cannot format the “Memory Stick”.	<ul style="list-style-type: none">• The write-protect tab on the “Memory Stick” is set to LOCK. → Set the tab to write. (p. 93)
Deleting all the images cannot be carried out.	<ul style="list-style-type: none">• The write-protect tab on the “Memory Stick” is set to LOCK. → Set the tab to write. (p. 93)
You cannot protect the image.	<ul style="list-style-type: none">• The write-protect tab on the “Memory Stick” is set to LOCK. → Set the tab to write. (p. 93)• The image to protect is not be played back. → Press MEMORY PLAY to play back the image. (p. 113)
You cannot write a print mark on the still image.	<ul style="list-style-type: none">• The write-protect tab on the “Memory Stick” is set to LOCK. → Set the tab to write. (p. 93)• The image to write a print mark is not be played back. → Press MEMORY PLAY to play back the image. (p. 113)
The photo save function does not work.	<ul style="list-style-type: none">• The write-protect tab on the “Memory Stick” is set to LOCK. → Set the tab to write. (p. 93)• The battery pack is dead. → Install a charged battery pack or use the AC power adaptor

(continued on the following page)

Troubleshooting

Others

Symptom	Cause and/or Corrective Actions
The title is not recorded.	<ul style="list-style-type: none">• The tape has no cassette memory. → Use a tape with cassette memory. (p. 77, 124)• The cassette memory is full. → Erase another title. (p. 80)• The tape is set to prevent accidental erasure. → Slide the write-protect tab so that red portion is not visible. (p. 15)• Nothing is recorded in that position on the tape. → Superimpose the title to the recorded position. (p. 77)
The cassette label is not recorded.	<ul style="list-style-type: none">• The tape has no cassette memory. → Use a tape with cassette memory. (p. 83, 124)• The cassette memory is full. → Erase some titles. (p. 80)• The tape is set to prevent accidental erasure. → Slide the write-protect tab so that red portion is not visible. (p. 15)
While editing using the i.LINK cable (DV connecting cable), recording picture cannot be monitored.	<ul style="list-style-type: none">• Remove the i.LINK cable (DV connecting cable), and connect it again.
Digital program editing does not function.	<ul style="list-style-type: none">• The input selector on the VCR is not set correctly. → Check the connection and set the input selector on the VCR again. (p. 56)• The camcorder is connected to DV equipment of other than Sony. → Set it to IR. (p. 57)• Setting program on a blank portion of the tape is attempted. → Set the PROGRAM again on a recorded portion. (p. 64)• The camcorder and the VCR are not synchronized. → Adjust the synchronicity. (p. 62)
The Remote Commander supplied with your camcorder does not work.	<ul style="list-style-type: none">• COMMANDER is set to OFF in the menu settings. → Set it to ON. (p. 85)• Something is blocking the infrared rays. → Remove the obstacle.• The batteries are inserted in the battery holder with the + - polarities incorrectly matching the + - marks. → Insert the batteries with the correct polarity. (p. 149)• The batteries are dead. → Insert new ones. (p. 149)
The picture from a TV or VCR does not appear even when your camcorder is connected to output on the TV or VCR.	<ul style="list-style-type: none">• Display is set to V-OUT/LCD in the menu settings. → Set it to LCD. (p. 85)
You cannot charge the battery pack.	<ul style="list-style-type: none">• The POWER switch is not set to OFF (CHG). → Set it to OFF (CHG).

Troubleshooting

Symptom	Cause and/or Corrective Actions
The melody or beep sounds for five seconds.	<ul style="list-style-type: none">• Moisture condensation has occurred. → Remove the cassette and leave your camcorder for at least one hour to acclimatize. (p. 138)• Some troubles has occurred in your camcorder. → Remove the cassette and insert it again, then operate your camcorder.
While charging the battery pack, no indicator appears or the indicator flashes in the display window.	<ul style="list-style-type: none">• The AC power adaptor is disconnected. → Connect it firmly. (p. 14)• The battery pack is not properly installed. → Install it properly.• Something is wrong with the battery pack. → Contact your Sony dealer or local authorized Sony service facility.
No function works though the power is on.	<ul style="list-style-type: none">• Disconnect the power cord of the AC power adaptor or remove the battery, then reconnect it in about one minute. Turn the power on. If the functions still do not work, open the LCD panel and press the RESET button beside the SELFTIMER button using a sharp-pointed object. (If you press the RESET button, all the settings including the date and time return to the default.) (p. 146)
When you set the POWER switch to VCR or OFF (CHG), if you move your camcorder, you may hear a clatter sound from inside your camcorder.	<ul style="list-style-type: none">• Your camcorder is not a malfunction.

Self-diagnosis display

Your camcorder has a self-diagnosis display function.

This function displays the current condition of your camcorder as a 5-digit code (a combination of a letter and figures) in the viewfinder, on the LCD screen or in the display window. If a 5-digit code is displayed, check the following code chart. The last two digits (indicated by □□) will differ depending on the state of your camcorder.

LCD screen (or Viewfinder)

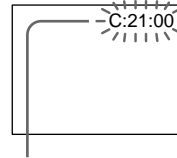

Self-diagnosis display

- C:□□:□□
You can service your camcorder yourself.
- E:□□:□□
Contact your Sony dealer or local authorized Sony facility.

Five-digit display	Cause and/or Corrective Actions
C:04:□□	<ul style="list-style-type: none"> • You are using a battery pack that is not an "InfoLITHIUM" battery pack. → Use an "InfoLITHIUM" battery pack. (p. 11)
C:21:□□	<ul style="list-style-type: none"> • Moisture condensation has occurred. → Remove the cassette and leave your camcorder for at least one hour to acclimatize. (p. 138)
C:22:□□	<ul style="list-style-type: none"> • The video heads are dirty. → Clean the heads using the cleaning cassette (not supplied). (p. 139)
C:31:□□ C:32:□□	<ul style="list-style-type: none"> • A malfunction other than the above that you can service has occurred. → Remove the cassette and insert it again, then operate your camcorder. → Disconnect the power cord of the AC power adaptor or remove the battery pack. After reconnecting the power source, operate your camcorder.
E:61:□□ E:62:□□	<ul style="list-style-type: none"> • A malfunction that you cannot service has occurred. → Contact your Sony dealer or local authorized Sony service facility and inform them of the 5-digit code. (example: E:61:10)

If you are unable to rectify the problem even if you try corrective actions a few times, contact your Sony dealer or local authorized Sony service facility.

Warning indicators and messages

If indicators and messages appear in the viewfinder, on the LCD screen or in the display window, check the following:

See the page in parentheses “()” for more information.

The indicators and messages are displayed in yellow.

Warning indicators

The video heads are dirty

Slow flashing:

- You need to clean the heads using the Sony DVM-12CLD cleaning cassette (not supplied) (p. 139).

The battery is dead or nearly dead

Slow flashing:

- The battery is nearly dead.
- The battery is dead (p. 11). Depending on conditions, the  indicator may flash, even if there are five to 10 minutes remaining.

Warning indicator as to tape

Slow flashing:

- The tape is near the end.
- No tape is inserted (p. 15).*
- The write-protect tab on the cassette is out (red) (p. 15).*

Fast flashing:

- The tape has run out (p. 15, 27).*

You need to eject the cassette

Slow flashing:

- The write-protect tab on the cassette is out (red) (p. 15).*

Fast flashing:

- Moisture condensation has occurred (p. 138).*
- The tape has run out (p. 15, 27).*
- The self-diagnosis display function is activated (p. 134).*

Moisture condensation has occurred*

Fast flashing:

- Eject the cassette, turn off your camcorder, and leave it for about 1 hour with the cassette compartment open (p. 138).

Warning indicator as to cassette memory

Slow flashing:

- No tape with cassette memory is inserted (p. 124).*

Self-diagnosis display (p. 134).

Warning indicator as to “Memory Stick” (DCR-TRV11/TRV20 only)

Slow flashing:

- No “Memory Stick” is inserted (p. 95).*

Fast flashing:

- The “Memory Stick” is not readable with your camcorder (p. 93).*

Warning indicator as to “Memory Stick” (DCR-TRV11/TRV20 only)

Fast flashing:

- Memory Stick is not formatted correctly (p. 88).
- The “Memory Stick” data is corrupted.*
- Different size of “Memory Stick” is inserted.

Warning indicator as to file

Slow flashing:

- The file is corrupted.
- The file is unreadable.

The still image is protected (DCR-TRV11/TRV20 only)



















Slow flashing:

- The still image is protected (p. 120).*

* You hear the melody or beep sound.

Warning indicators and messages

Warning messages

-  CLOCK SET Reset the date and time (p. 92).
- FOR “InfoLITHIUM” Use an “InfoLITHIUM” battery pack (p. 11).
BATTERY ONLY
-  CLEANING CASSETTE
The video heads are dirty (p. 139).
-  FULL The tape cassette memory is full.
-  16BIT AUDIO MODE is set to 16BIT (p. 89).* You cannot dub new sound.
-  REC MODE REC MODE is set to LP (p. 89).* You cannot dub new sound.
-  TAPE There is no recorded portion on the tape. You cannot dub new sound.
-  “i.LINK” CABLE i.LINK cable is connected (p. 76).* You cannot dub new sound.
-  FULL The “Memory Stick” is full* (DCR-TRV11/TRV20 only) (p. 103)
-   The write-protect tab on the “Memory Stick” is set to LOCK (p. 93).* (DCR-TRV11/TRV20 only)
-  NO FILE No still image is recorded on the “Memory Stick” (p. 113).* (DCR-TRV11/TRV20 only)
-  NO MEMORY STICK
No “Memory Stick” is inserted (p. 95).
(DCR-TRV11/TRV20 only)
-  MEMORY STICK ERROR
The “Memory Stick” data is corrupted.
(DCR-TRV11/TRV20 only)
-  FORMAT ERROR
The “Memory Stick” is not recognized. Check the format (p. 94).
(DCR-TRV11/TRV20 only)
-   DIRECTORY ERROR
There is more than two same directions.
- COPY INHIBIT The tape contains copyright control signals for copyright protection of software (p. 124).*
-  TAPE END The tape has reached the end of the tape (p. 27).*
-  NO TAPE Insert a cassette tape (p. 15).*

* You hear the melody or beep sound.

Using your camcorder abroad

Using your camcorder abroad

You can use your camcorder in any country or area with the AC power adaptor supplied with your camcorder within 100 V to 240 V AC, 50/60 Hz.

When charging the battery pack, use a commercially available AC plug adaptor [a], if necessary, depending on the design of the wall outlet [b].

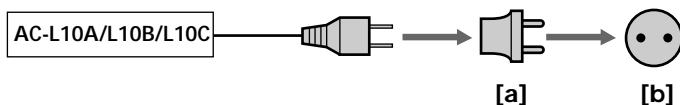

Your camcorder is an NTSC system based camcorder. If you want to view the playback picture on a TV, it must be an NTSC system based TV with the AUDIO/VIDEO input jack.

The following shows TV color systems used overseas.

NTSC system

Bahama Islands, Bolivia, Canada, Central America, Chile, Colombia, Ecuador, Jamaica, Japan, Korea, Mexico, Peru, Surinam, Taiwan, the Philippines, the U.S.A., Venezuela, etc.

PAL system

Australia, Austria, Belgium, China, Czech Republic, Denmark, Finland, Germany, Great Britain, Holland, Hong Kong, Italy, Kuwait, Malaysia, New Zealand, Norway, Portugal, Singapore, Slovak Republic, Spain, Sweden, Switzerland, Thailand, etc.

PAL-M system

Brazil

PAL-N system

Argentina, Paraguay, Uruguay

SECAM system



Bulgaria, France, Guyana, Hungary, Iran, Iraq, Monaco, Poland, Russia, Ukraine, etc.

Simple setting of clock by time difference

You can easily set the clock to the local time by setting a time difference. Select WORLD TIME in the menu settings. See page 85 for more information.

Maintenance information and precautions

Moisture condensation

If your camcorder is brought directly from a cold place to a warm place, moisture may condense inside your camcorder, on the surface of the tape, or on the lens. In this condition, the tape may stick to the head drum and be damaged or your camcorder may not operate correctly. If there is moisture inside your camcorder, the beep sounds and the  indicator flashes. When the  indicator flashes at the same time, the cassette is inserted in your camcorder. If moisture condenses on the lens, the indicator will not appear.

If moisture condensation occurred

None of the functions except cassette ejection will work. Eject the cassette, turn off your camcorder, and leave it for about one hour with the cassette compartment open. Your camcorder can be used again if the  indicator does not appear when the power is turned on again.

Note on moisture condensation

Moisture may condense when you bring your camcorder from a cold place into a warm place (or vice versa) or when you use your camcorder in a hot place as follows:

- You bring your camcorder from a ski slope into a place warmed up by a heating device.
- You bring your camcorder from an air-conditioned car or room into a hot place outside.
- You use your camcorder after a squall or a shower.
- You use your camcorder in a high temperature and humidity place.

How to prevent moisture condensation



When you bring your camcorder from a cold place into a warm place, put your camcorder in a plastic bag and tightly seal it. Remove the bag when the air temperature inside the plastic bag has reached the surrounding temperature (after about one hour).

Maintenance information and precautions

Maintenance information

Cleaning the video head

To ensure normal recording and clear pictures, clean the video heads. The video head may be dirty when:

- mosaic-pattern noise appears on the playback picture.
- playback pictures do not move.
- playback pictures do not appear.
- the  indicator and " CLEANING CASSETTE" message appear one after another or the  indicator flashes on the LCD screen or in the viewfinder.

If the above problem, [a] or [b] occurs, clean the video heads for 10 seconds with the Sony DVM-12CLD cleaning cassette (not supplied). Check the picture and if the above problem persists, repeat cleaning.

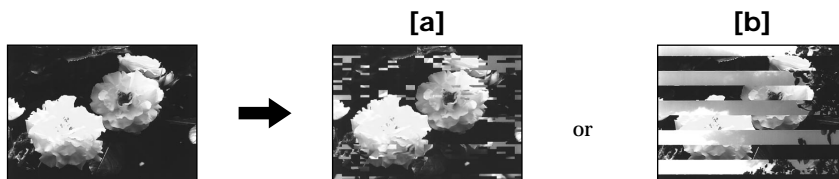

Cleaning the LCD screen

If fingerprints or dust make the LCD screen dirty, we recommend using a LCD Cleaning Kit (not supplied) to clean the LCD screen.

Charging the vanadium-lithium battery in your camcorder

Your camcorder is supplied with a vanadium-lithium battery installed so as to retain the date and time, etc., regardless of the setting of the POWER switch. The vanadium-lithium battery is always charged as long as you are using your camcorder. The battery, however, will get discharged gradually if you do not use your camcorder. It will be completely discharged in about four months if you do not use your camcorder at all. Even if the vanadium-lithium battery is not charged, it will not affect the camcorder operation. To retain the date and time, etc., charge the battery if the battery is discharged.

Charging the vanadium-lithium battery:

- Connect your camcorder to house current using the AC power adaptor supplied with your camcorder, and leave your camcorder with the POWER switch turned off for more than 24 hours.
- Or install the fully charged battery pack in your camcorder, and leave your camcorder with the POWER switch turned off for more than 24 hours.

Precautions

Camcorder operation

- Operate your camcorder on 7.2 V (battery pack) or 8.4 V (AC power adaptor).
- For DC or AC operation, use the accessories recommended in this operating instructions.
- If any solid object or liquid get inside the casing, unplug your camcorder and have it checked by a Sony dealer before operating it any further.
- Avoid rough handling or mechanical shock. Be particularly careful of the lens.
- Keep the POWER switch set to OFF (CHG) when you are not using your camcorder.
- Do not wrap your camcorder with a towel, for example, and operate it. Doing so might cause heat to build up inside.
- Keep your camcorder away from strong magnetic fields or mechanical vibration.
- Do not touch the LCD screen with your fingers or a sharp-pointed object.
- If your camcorder is used in a cold place, a residual image may appear on the LCD screen. This is not a malfunction.
- While using your camcorder, the back of the LCD screen may heat up. This is not a malfunction.

On handling tapes

- Do not insert anything into the small holes on the rear of the cassette. These holes are used to sense the type and thickness of the tape and if the recording tab is in or out.
- Do not open the tape protect cover or touch the tape.
- Avoid touching or damaging the terminals. To remove dust, clean the terminals with a soft cloth.

Camcorder care

- Remove the tape, and periodically turn on the power, operate the CAMERA and VCR sections and play back a tape for about three minutes when your camcorder is not to be used for a long time.
- Clean the lens with a soft brush to remove dust. If there are fingerprints on the lens, remove them with a soft cloth.
- Clean the camcorder body with a dry soft cloth, or a soft cloth lightly moistened with a mild detergent solution. Do not use any type of solvent which may damage the finish.
- Do not let sand get into your camcorder. When you use your camcorder on a sandy beach or in a dusty place, protect it from the sand or dust. Sand or dust may cause your camcorder to malfunction, and sometimes this malfunction cannot be repaired.

AC power adaptor

- Unplug the unit from the wall outlet when you are not using the unit for a long time. To disconnect the power cord, pull it out by the plug. Never pull the power cord itself.
- Do not operate the unit with a damaged cord or if the unit has been dropped or damaged.
- Do not bend the power cord forcibly, or place a heavy object on it. This will damage the cord and may cause fire or electrical shock.
- Prevent metallic objects from coming into contact with the metal parts of the connecting section. If this happens, a short may occur and the unit may be damaged.
- Always keep metal contacts clean.
- Do not disassemble the unit.
- Do not apply mechanical shock or drop the unit.

Maintenance information and precautions

- While the unit is in use, particularly during charging, keep it away from AM receivers and video equipment. AM receivers and video equipment disturb AM reception and video operation.
- The unit becomes warm during use. This is not a malfunction.
- Do not place the unit in locations that are:
 - Extremely hot or cold
 - Dusty or dirty
 - Very humid
 - Vibrating

Battery pack

- Use only the specified charger or video equipment with the charging function.
- To prevent accident from a short circuit, do not allow metal objects to come into contact with the battery terminals.
- Keep the battery pack away from fire.
- Never expose the battery pack to temperatures above 140°F (60°C), such as in a car parked in the sun or under direct sunlight.
- Keep the battery pack dry.
- Do not expose the battery pack to any mechanical shock.
- Do not disassemble nor modify the battery pack.
- Attach the battery pack to the video equipment securely.
- The battery pack is not resistant to water. Do not wet the battery pack.
- Unless you use the battery pack for a long period, store the battery pack after you charge it fully and use it completely once a year.
- Store the battery pack in a cool, dry place.

Notes on dry batteries

To avoid possible damage from battery leakage or corrosion, observe the following:

- Be sure to insert the batteries with the + – polarities matched to the + – marks.
- Dry batteries are not rechargeable.
- Do not use a combination of new and old batteries.
- Do not use different types of batteries.
- Current flows from batteries when you are not using them for a long time.
- Do not use leaking batteries.

If batteries are leaking

- Wipe off the liquid in the battery compartment carefully before replacing the batteries.
- If you touch the liquid, wash it off with water.
- If the liquid get into your eyes, wash your eyes with a lot of water and then consult a doctor.

If any problem occurs, unplug your camcorder and contact your nearest Sony dealer.

Specifications

Video camera recorder

System

Video recording system
2 rotary heads
Helical scanning system
Audio recording system
Rotary heads, PCM system
Quantization: 12 bits (Fs 32 kHz, stereo 1, stereo 2), 16 bits (Fs 48 kHz, stereo)
Video signal
NTSC color, EIA standards
Usable cassette
Mini DV cassette with the ^{Mini} DV mark printed
Tape speed
SP: Approx. 18.81 mm/s
LP: Approx. 12.56 mm/s
Recording/playback time (using cassette DVM60)
SP: 1 hour
LP: 1.5 hours
Fastforward/rewind time (using cassette DVM60)
Approx. 2 min. and 30 seconds
Viewfinder
Electric viewfinder (color)
Image device
1/4 type CCD (Charge Coupled Device)
DCR-TRV6/TRV11:
Approx. 680,000 pixels
(Effective: Approx. 340,000 pixels)
DCR-TRV20:
Approx. 1,070,000 pixels
(Effective (still): 1,000,000 pixels)
(Effective (moving): 690,000 pixels)
Lens
Carl Zeiss
Combined power zoom lens
Filter diameter
DCR-TRV6/TRV11: 1 3/16 in. (30 mm)
DCR-TRV20: 1 1/2 in. (37 mm)
10× (Optical), 120× (Digital)
Focal length
DCR-TRV6/TRV11:
5/32 - 1 5/16 in. (3.3 - 33 mm)
DCR-TRV20:
3/16 - 1 11/16 in. (4.2 - 42 mm)
When converted to a 35 mm still camera

DCR-TRV6/TRV11:
Camera/Memory mode:
1 11/16 - 16 5/8 in. (42 - 420 mm)
DCR-TRV20:
Camera mode:
1 15/16 - 19 in. (48 - 480 mm)
Memory mode:
1 5/8 - 15 3/4 in. (40 - 400 mm)
Color temperature
Auto, HOLD (Hold), ☀-Indoor (3200K), *Outdoor (5800K)
Minimum illumination
DCR-TRV6/TRV11: 5 lux (F 1.7)
DCR-TRV20: 7 lux (F 1.8)
0 lux (in the NightShot mode)*
* Objects unable to be seen due to the dark can be shot with infrared lighting.

Input/Output connectors

S video input/output
4-pin mini DIN
Luminance signal: 1 V_{p-p}, 75 ohms, unbalanced
Chrominance signal: 0.286 V_{p-p}, 75 ohms, unbalanced
Audio/Video input/output
AV MINI JACK, 1 V_{p-p}, 75 ohms, unbalanced, sync negative
327 mV, (at output impedance more than 47 kilohms)
Output impedance with less than 2.2 kilohms/Stereo minijack (ø 3.5mm)
Input impedance more than 47 kilohms
Ⓜ DV input/output
4-pin connector
Headphone jack
Stereo minijack (ø 3.5 mm)
Ⓛ (LANC) jack (DCR-TRV6)
DIGITAL I/O/Ⓛ (LANC) jack (DCR-TRV11/TRV20)
Mini-minijack (ø 2.5 mm)
MIC jack
Minijack, 0.388 mV low impedance with 2.5 to 3.0 V DC, output impedance 6.8 kilohms (ø 3.5 mm)
Stereo type

LCD screen

Picture

DCR-TRV6:
2.5 inches measured diagonally
2 × 1 1/2 in. (50.3 × 37.4 mm)
DCR-TRV11/TRV20:
3.5 inches measured diagonally
2 7/8 × 2 in. (72.4 × 50.4 mm)
Total dot number
DCR-TRV6: 200,640 (880 × 228)
DCR-TRV11: 184,800 (840 × 220)
DCR-TRV20: 246,400 (1120 × 220)

General

Power requirements

7.2 V (battery pack)
8.4 V (AC power adaptor)

Average power consumption (when using the battery pack)

During camera recording using LCD

DCR-TRV6: 3.4 W
DCR-TRV11: 3.5 W
DCR-TRV20: 4.5 W

Viewfinder

DCR-TRV6: 2.5 W
DCR-TRV11: 2.6 W
DCR-TRV20: 3.7 W

Operating temperature

32 °F to 104 °F (0 °C to 40 °C)

Storage temperature

-4 °F to +140 °F
(-20 °C to +60 °C)

Dimensions (Approx.)

DCR-TRV6/TRV11:
2 7/8 × 3 3/4 × 6 1/2 in.
(71 × 93 × 163 mm) (w/h/d)

DCR-TRV20:

2 7/8 × 3 3/4 × 6 3/4 in.
(71 × 93 × 170 mm) (w/h/d)

Mass (approx.)

DCR-TRV6: 1 lb 4 oz (580 g)
DCR-TRV11: 1 lb 5 oz (620 g)
DCR-TRV20: 1 lb 7 oz (680 g)
main unit only

DCR-TRV6: 1 lb 7 oz (680 g)
DCR-TRV11: 1 lb 9 oz (720 g)

DCR-TRV20: 1 lb 11 oz (780 g)
including the battery pack, NP-FM50, cassette DVM60, lens cap and shoulder strap

Supplied accessories

See page 5.

Specifications

AC power adaptor

Power requirements

100 - 240 V AC, 50/60 Hz

Power consumption

23 W

Output voltage

DC OUT: 8.4 V, 1.5 A in the operating mode

Operating temperature

32 °F to 104 °F (0 °C to 40 °C)

Storage temperature

-4 °F to +140 °F (-20 °C to +60 °C)

Dimensions (approx.)

5 × 1 9/16 × 2 1/2 in.

(125 × 39 × 62 mm) (w/h/d)

excluding projecting parts

Mass (approx.)

9.8 oz (280 g)

excluding mains lead

Cord length (approx.)

Power cord: 6.6 feet (2 m)

Connecting cord: 5.2 feet (1.6

m)

Battery pack

Output voltage

DC 7.2 V

Capacity

8.5 Wh (1,180 mA)

Dimensions (approx.)

1 9/16 × 13/16 × 2 1/4 in.

(38.2 × 20.5 × 55.6 mm)

(w/h/d)

Mass (approx.)

2.7 oz (76 g)

Type

Lithium ion

"Memory Stick" (DCR-TRV11/TRV20 only)

Memory

Flash memory

4MB: MSA-4A

Operating voltage

2.7-3.6V

Power consumption

Approx. 45mA in the operating mode

Approx. 130µA in the standby mode

Dimensions (approx.)

2 × 1/8 × 7/8 in.

(50 × 2.8 × 21.5 mm) (w/h/d)

Mass (approx.)

0.14 oz (4 g)

Design and specifications are subject to change without notice.

Identifying the parts and controls

Camcorder

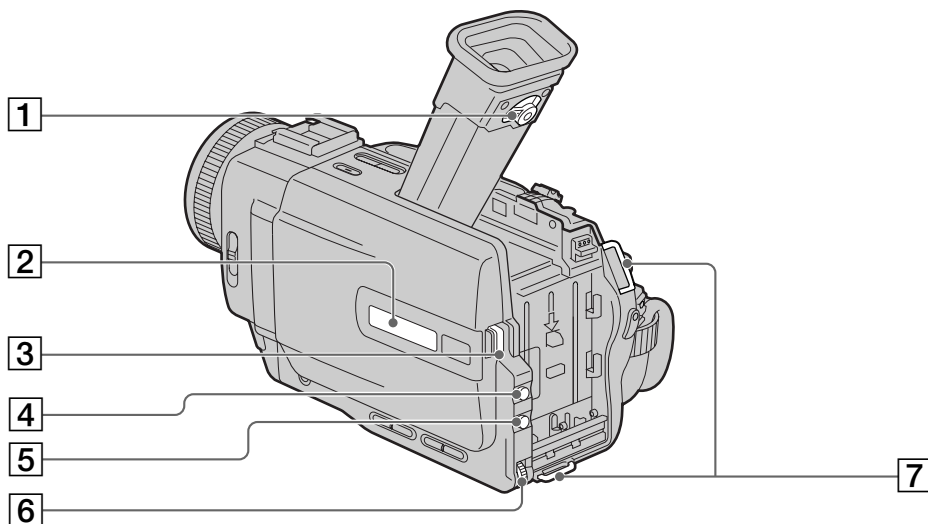

1 Viewfinder lens adjustment lever
(p. 19)

2 Display window (p. 150)

3 OPEN button (p. 16)

4 PROGRAM AE button (p. 41)

5 EXPOSURE button (p. 43)

6 SEL/PUSH EXEC dial (p. 33, 85)

7 Hooks for shoulder strap



This mark indicates that this product is a genuine accessory for Sony video products.

When purchasing Sony video products, Sony recommends that you purchase accessories with this "GENUINE VIDEO ACCESSORIES" mark.

Attaching the shoulder strap

Attach the shoulder strap supplied with your camcorder to the hooks for the shoulder strap.

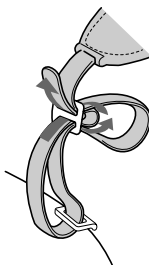

Identifying the parts and controls

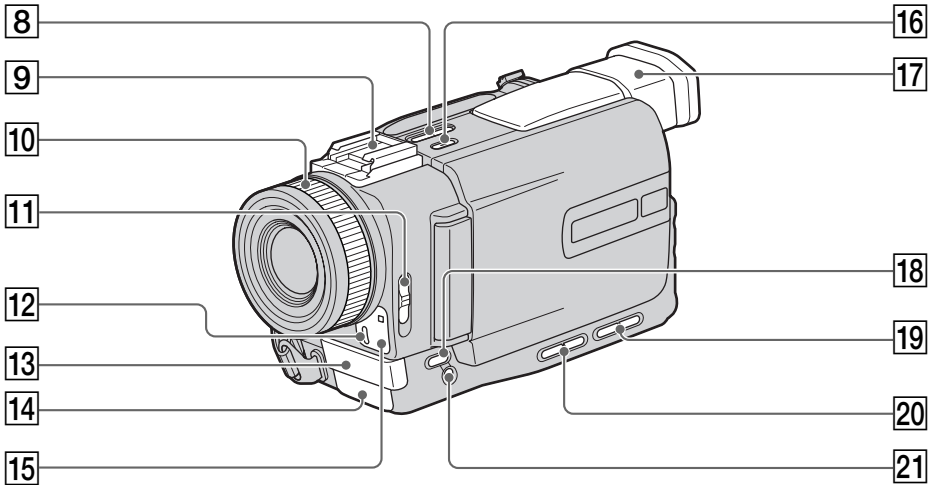

- | | |
|---|---|
| 8 EDITSEARCH buttons (p. 24) | 15 Remote sensor |
| 9 Intelligent accessory shoe (p. 73) | 16 SUPER LASER LINK button (p. 29) |
| 10 Focus ring (p. 44) | 17 Viewfinder (p. 19) |
| 11 FOCUS switch (p. 44) | 18 FADER button (p. 35) |
| 12 Camera recording lamp (p. 16) | 19 VOLUME buttons (p. 25) |
| 13 Microphone | 20 LCD BRIGHT +/- buttons (p. 18) |
| 14 Infrared rays emitter (p. 22, 29, 59) | 21 BACK LIGHT button (p. 21) |



Notes on the intelligent accessory shoe

- The intelligent accessory shoe supplies power to optional accessories such as a video light or microphone.
- The intelligent accessory shoe is linked to the POWER switch, allowing you to turn the power supplied by the shoe on and off. Refer to the operating instructions of the accessory for further information.
- The intelligent accessory shoe has a safety device for fixing the installed accessory securely. To connect an accessory, press down and push it to the end, and then tighten the screw.
- To remove an accessory, loosen the screw, and then press down and pull out the accessory.

Identifying the parts and controls

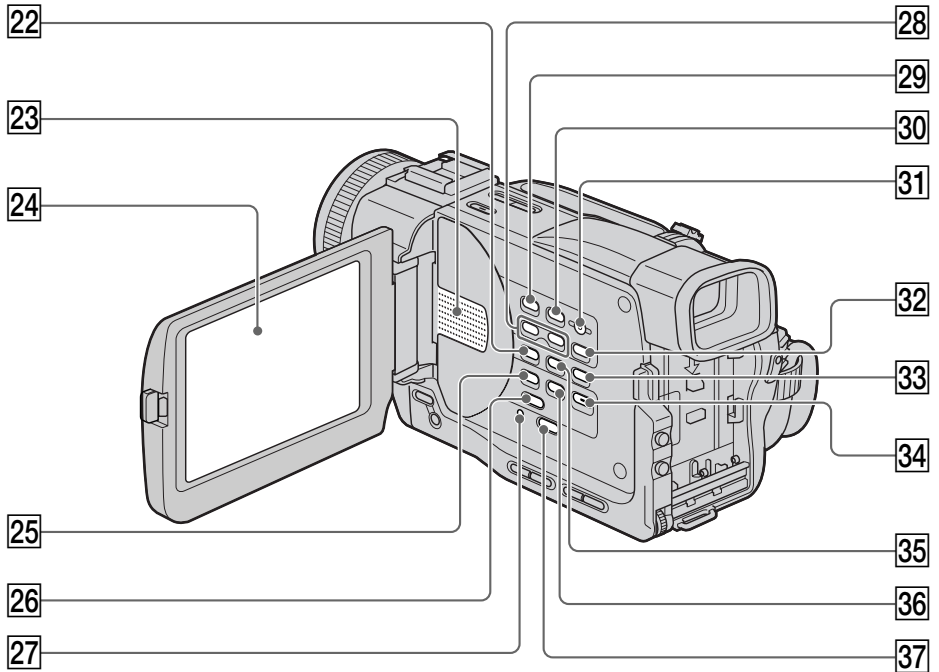

22 DISPLAY button (p. 26)

23 Speaker

24 LCD screen (p. 17)

25 DIGITAL EFFECT button (p. 38, 46)

26 PB ZOOM button (p. 47, 118)

27 RESET button (p. 133)

28 MEMORY +/- buttons
(DCR-TRV11/TRV20 only) (p. 106, 114)

29 MEMORY PLAY button (p. 113)
(DCR-TRV11/TRV20 only)

30 MEMORY INDEX button
(DCR-TRV11/TRV20 only) (p. 114)

31 MEMORY DELETE button
(DCR-TRV11/TRV20 only) (p. 121)

32 MEMORY MIX button (p. 106)
(DCR-TRV11/TRV20 only)

33 END SEARCH button (p. 24)

34 MENU button (p. 33, 85)

35 DATA CODE button (p. 26)

36 TITLE button (p. 77, 81)

37 SELFTIMER button (p. 23, 31, 104)

Identifying the parts and controls

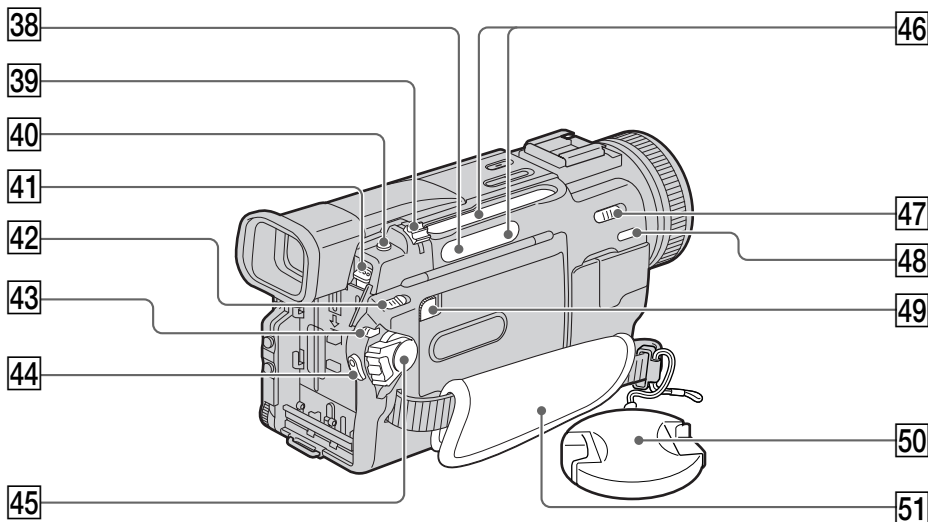

38 Access lamp (DCR-TRV11/TRV20 only)
(p. 95)

39 Power zoom lever (p. 20)

40 PHOTO button (p. 30, 100)

41 BATT release button (p. 10)

42 MEMORY OPEN button
(DCR-TRV11/TRV20 only) (p. 95)

43 LOCK switch (DCR-TRV11/TRV20
only) (p. 16)

44 START/STOP button (p. 16)

45 POWER switch (p. 16)

46 Video control buttons (p. 25)

■ STOP (stop)

◀ REW (rewind)

▶ PLAY (playback)

▶▶ FF (fastforward)

|| PAUSE (pause)

● REC (record)

The control buttons light up when you
set the POWER switch to VCR.

47 NIGHTSHOT switch (p. 22)

48 SUPER NIGHTSHOT button (p. 22)

49 MEMORY RELEASE button (p. 95)
(DCR-TRV11/TRV20 only)

50 Lens Cap (p. 16)

51 Grip strap

Fastening the grip strap

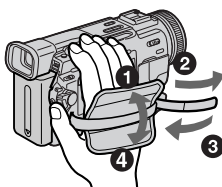

Fasten the grip strap firmly.

Identifying the parts and controls

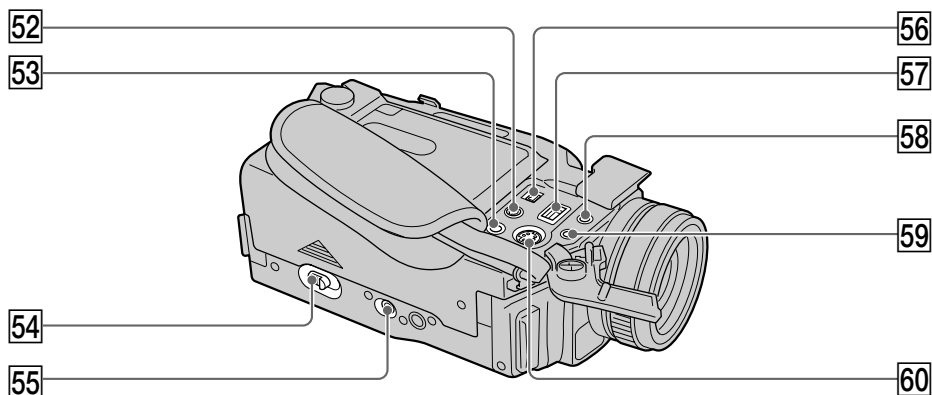

- 52** AUDIO/VIDEO jack (p. 28, 54, 67)
- 53** (headphones) jack
When you use headphones, the speaker on your camcorder is silent.
- 54** OPEN/EJECT lever (p. 15)
- 55** Tripod receptacle
Make sure that the length of the tripod screw is less than 9/32 inch (6.5 mm). Otherwise, you cannot attach the tripod securely and the screw may damage your camcorder.
- 56** DV IN/OUT jack (p. 55, 66, 69)
This “i.LINK” mark is a trademark of Sony Corporation and indicates that this product is in agreement with IEEE 1394-1995 specifications and their revisions.
- 57** DC IN jack (p. 11)
- 58** DIGITAL I/O (LANC) control jack (DCR-TRV11/TRV20 only)
 (LANC) control jack (DCR-TRV6 only)
LANC stands for Local Application Control Bus System. The control jack is used for controlling the tape transport of video equipment and other peripherals connected to the video equipment. This jack has the same function as the jack indicated as CONTROL L or REMOTE.
- 59** MIC jack (PLUG IN POWER)
Connect an external microphone (not supplied). This jack also accepts a “plug-in-power” microphone.
- 60** S VIDEO jack (p. 28, 54, 67)

The DV IN/OUT jack is i.LINK compatible.

Note on the Carl Zeiss lens

Your camcorder is equipped with a Carl Zeiss lens which can reproduce a fine image.

The lens for your camcorder was developed jointly by Carl Zeiss, in Germany, and Sony Corporation. It adopts the MTF* measurement system for video camera and offers a quality as the Carl Zeiss lens.

* MTF is an abbreviation of Modulation Transfer Function/Factor.

The value number indicates the amount of light of a subject penetrating into the lens.

Identifying the parts and controls

Remote Commander

The buttons that have the same name on the Remote Commander as on your camcorder function identically to the buttons on your camcorder.

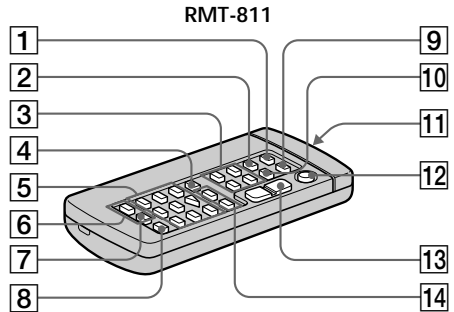
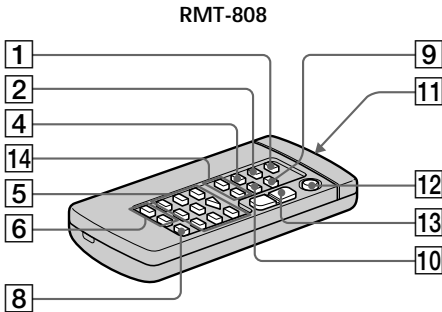

1 PHOTO button (p. 30, 100)

2 DISPLAY button (p. 26)

3 Memory control buttons (p. 106)
PLAY/INDEX/+/- button

4 SEARCH MODE button (p. 49, 50, 52)

5 Video control buttons (p. 25)

6 REC button (p. 67, 69, 71)

7 MARK button (DCR-TRV11/TRV20
only) (p. 64, 67, 69, 71)

8 AUDIO DUB button (p. 75)

9 ZERO SET MEMORY button (p. 48)

10 DATA CODE button (p. 26)

11 Transmitter
Point toward the remote sensor to
control your camcorder after turning on
your camcorder.

12 START/STOP button (p. 16)

13 Power zoom button (p. 20)

14 ◀▶/▶▶ buttons (p. 49, 50, 52)

To prepare the Remote Commander

Insert two size AA (R6) batteries by matching the + and - polarities on the batteries to the + - marks inside the battery compartment.

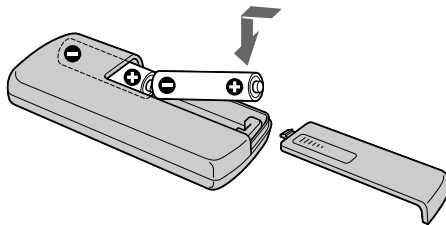

Notes on the Remote Commander

- Point the remote sensor away from strong light sources such as direct sunlight or overhead lighting. Otherwise, the Remote Commander may not function properly.
- Your camcorder works in the commander mode VTR 2. Commander modes 1, 2 and 3 are used to distinguish your camcorder from other Sony VCRs to avoid remote control misoperation. If you use another Sony VCR in the commander mode VTR 2, we recommend changing the commander mode or covering the sensor of the VCR with black paper.

Identifying the parts and controls

Operation indicators

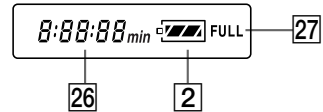
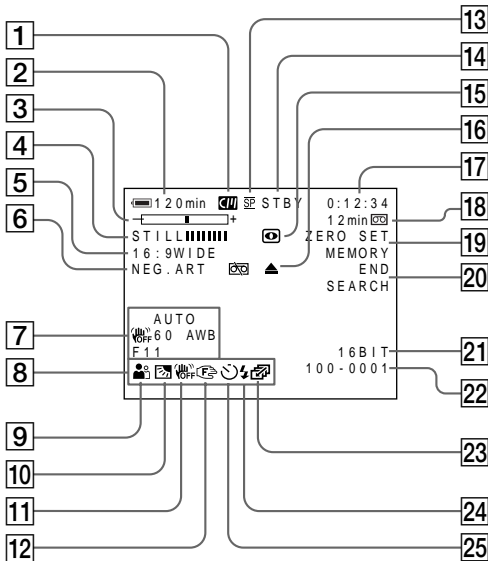

- 1 Cassette memory indicator (p. 21, 124)
- 2 Remaining battery time indicator (p. 21)
- 3 Zoom indicator (p. 20)/Exposure indicator (p. 43)/Data file name indicator (DCR-TRV11/TRV20 only) (p. 93)
- 4 Digital effect indicator (p. 38)/MEMORY MIX indicator (DCR-TRV11/TRV20 only) (p. 105)/FADER indicator (p. 35)
- 5 16:9WIDE indicator (p. 34)
- 6 Picture effect indicator (p. 37)
- 7 Data code indicator (p. 26)
- 8 LCD bright indicator (p. 18)/Volume indicator (p. 25)/Date indicator (p. 21)
- 9 PROGRAM AE indicator (p. 41)
- 10 Backlight indicator (p. 21)
- 11 SteadyShot off indicator (p. 86)
- 12 Manual focus/Infinity indicator (p. 44)
- 13 Recording mode indicator (p. 21, 89)
- 14 STBY/REC indicator (p. 16)/Video control mode indicator (p. 27)/Image size indicator (p. 98)/Image quality mode indicator (DCR-TRV11/TRV20 only) (p. 96)
- 15 NIGHTSHOT indicator (p. 22)
- 16 Warning indicators (p. 135)
- 17 Tape counter indicator (p. 48)/Time code indicator (p. 21)/Self-diagnosis indicator (p. 134)/Tape photo indicator (p. 30)/Memory photo indicator (DCR-TRV11/TRV20 only) (p. 100)/Image number indicator (DCR-TRV11/TRV20 only) (p. 114)
- 18 Remaining tape indicator (p. 21)/Memory playback indicator (DCR-TRV11/TRV20 only) (p. 114)
- 19 ZERO SET MEMORY indicator (p. 48)
- 20 END SEARCH indicator (p. 24)
- 21 Audio mode indicator (p. 89)
- 22 Data file name indicator (DCR-TRV11/TRV20 only) (p. 105)/Time indicator (p. 21)
This indicator appears when the MEMORY MIX functions work.
- 23 Continuous mode indicator (DCR-TRV11/TRV20 only) (p. 102)
- 24 Video flash ready indicator
This indicator appears when you use the video flash light (not supplied).
- 25 Self-timer indicator (p. 23)
- 26 Remaining battery time indicator (p. 48)/Tape counter (p. 11)/Memory counter (DCR-TRV11/TRV20 only)/Time code indicator (p. 21, 114)
- 27 FULL charge indicator (p. 11)

Quick Function Guide

Functions to adjust exposure (in the recording mode)

- In a dark place NIGHTSHOT (p. 22)
- In insufficient light Low lux mode (p. 41)
- In dark environments such as sunset, fireworks, or general night views Sunset & moon mode (p. 41)
- Shooting backlit subjects BACK LIGHT (p. 21)
- In spotlight, such as at the theater or a formal event Spotlight mode (p. 41)
- In strong light or reflected light, such as at a beach in midsummer or on a ski slope Beach & ski mode (p. 41)

Functions to give images more impact (in the recording mode)

- Smooth transition between scenes FADER (p. 35)
- Taking a still picture TAPE PHOTO (p. 30)/MEMORY PHOTO (p. 100)
- Digital processing of images PICTURE EFFECT (p. 37)/DIGITAL EFFECT (p. 38)
- Creating a soft background for subjects Soft portrait mode (p. 41)
- Superimposing a title TITLE (p. 77)

Functions to give a natural appearance to your recordings (in the recording mode)

- Preventing deterioration of picture quality in digital zoom D ZOOM [MENU] (p. 85)
- Focusing manually Manual focus (p. 44)
- Shooting distant subjects Landscape mode (p. 41)
- Recording fast-moving subjects Sports lesson mode (p. 41)

Functions to be used in editing (in the recording mode)

- Watching the picture on a wide-screen TV Wide mode (p. 34)
- Viewing images using a personal computer "Memory Stick" (p. 93)
(DCR-TRV11/TRV20 only)

Functions to be used after recording (in the playback mode)

- Digital processing of recorded images PICTURE EFFECT (p. 45)/DIGITAL EFFECT (p. 46)
- Displaying the date/time or various settings when you recorded Data code (p. 26)
- Quickly locating a desired scene Zero set memory (p. 48)
- Searching for scenes having a title Title search (p. 49)
- Searching for scenes recorded in the photo mode Photo search (p. 52)
- Scanning scenes recorded in the photo mode Photo scan (p. 53)
- Playing back monaural sound or sub sound HiFi SOUND [MENU] (p. 85)
- Playing back the picture on a TV without connecting cord SUPER LASER LINK (p. 29)
- Enlarging still images PB ZOOM(p. 47)/Memory PB ZOOM (p. 118) (DCR-TRV11/TRV20 only)

Index

A, B

AC power adaptor	11
Adjusting viewfinder	19
Audio dubbing	73
AUDIO MIX	87
Audio mode	89
AUTO SHTR	86
A/V connecting cable	28, 54, 67
BACK LIGHT	21
Battery pack	10
Beep	91
BOUNCE	35

C, D

Camera chromakey	105
Cassette memory	8, 125
Charging battery	11
Charging vanadium-lithium battery	139
Clock set	92
Connection (viewing on TV)	29
(dubbing a tape)	54, 109
Continuous	102
Data code	26
Date search	50
DEMO	90
DIGITAL EFFECT	38, 46
DIGITAL I/O/☑ (LANC)	148
Digital program editing	56
DISPLAY	26
Dual sound track tape	125
Dubbing a tape	54
DV connecting cable	55, 69

E

EDITSEARCH	24
END SEARCH	24, 27
Exposure	43
External microphone (not supplied)	148

F, G, H

FADER	35
Fade in/out	35
FLASH MOTION	38
FOCUS	44
Format	93
Full charge	11
Grip strap	147
Headphone jack	148
Heads	139
HiFi SOUND	87

I, J, K, L

i.LINK	126
Image protection	120
Image quality mode	96
INDEX (Multiple) display ...	114
"InfoLITHIUM" battery	13
Infrared rays emitter ...	22, 29, 59
Insert editing	71
Intelligent accessory shoe ...	145
JPEG	93
LANC	148
Labeling a cassette	83
LCD screen	17
LUMINANCEKEY	38

M, N

Main sound	87
Manual focus	44
Memory chromakey	105
Memory luminancekey	105
MEMORY MIX	105
Memory PB ZOOM	118
Memory photo recording	100
Memory Stick	93
Menu settings	85
Memory overlap	105
M.FADER	35
Mirror mode	17
Moisture condensation	138
MONOTONE	35
NIGHTSHOT	22
Normal charge	11
NTSC system	137

O, P, Q

OLD MOVIE	38
Operation indicators	150
OVERLAP	35, 105
PB ZOOM	47
Photo scan	53
Photo search	52
PICTURE EFFECT	37, 45
Picture search	27
Playback pause	27
Power sources (house current)	14
(car battery)	14
(battery pack)	10
Power zoom	20
Print mark	123
PROGRAM AE	41

R

RANDOM DOT	35
Rec review	24
Recording time	12
Remaining battery time indicator	21
Remaining tape indicator	21
Remote commander	149
Remote sensor	145
RESET	133

S

S video jack	28, 54, 67
Self-diagnosis display	134
Self-timer recording	23
SEL/PUSH EXEC dial	85
Serial port adaptor	115
Shoulder strap	144
Signal convert function	66
Skip scan	27
Slide show	119
Slow playback	27
SLOW SHUTTER	38
STEADYSHOT	86
Stereo tape	125
STILL	38
Sub sound	87
SUPER LASER LINK	29
SUPER NIGHTSHOT	22

T, U, V

Tape counter	21, 48
Tape photo recording	30
Telephoto	20
Time code	21
Title	77, 81
Title search	49
TRAIL	38
Transition	17
TV color systems	137

W, X, Y, Z

Warning indicators	135
White balance	33
Wide-angle	20
Wide mode	34
WIPE	35
WORLD TIME	91
Write-protect tab	15
Zero set memory	48, 71
Zoom	20